

Johann Sebastian
BACH

Messe in h-Moll

Mass in B minor

BWV 232

für Soli (SSATB), Chor (SSAATTBB)
3 Trompeten, Corno da caccia, Pauken
2 Flöten, 3 Oboen (1./2. auch Oboe d'amore), 2 Fagotte
2 Violinen, Viola und Continuo

for soli (SSATB), choir (SSAATTBB)
3 trumpets, corno da caccia, timpani
2 flutes, 3 oboes (1st/2nd also oboe d'amore), 2 bassoons
2 violins, viola and continuo

herausgegeben von / edited by
Ulrich Leisinger

Edition Staatsbibliothek zu Berlin

Mit Faksimile der Hauptquellen und detailliertem Kritischen Bericht auf DVD
Including a facsimile of the main sources and detailed Critical Report on DVD

Stuttgarter Bach-Ausgaben · Urtext

In Zusammenarbeit mit / In collaboration with Bach-Archiv Leipzig

Partitur / Full score



Carus 31.232

Zu diesem Werk ist folgendes Aufführungsmaterial erhältlich:

Partitur kartoniert (Carus 31.232/00)
Partitur, Leinen, mit DVD (Carus 31.232/01)
Studienpartitur (Carus 31.232/07)
Klavierauszug (Carus 31.232/03)
Chorpartitur (Carus 31.232/05)
komplettes Orchestermaterial (Carus 31.232/19)

The following performance material is available:

full score, paperback (Carus 31.232/00)
full score, clothbound, with DVD (Carus 31.232/01)
study score (Carus 31.232/07)
vocal score (Carus 31.232/03)
choral score (Carus 31.232/05)
complete orchestral material (Carus 31.232/19)

Inhalt / Contents

Vorwort / Foreword	IV
I. Missa	
1. Kyrie I	2
2. Christe eleison	28
3. Kyrie II	34
4a. Gloria in excelsis Deo	38
4b. Et in terra pax	50
5. Laudamus te	68
6. Gratias agimus tibi	76
7a. Domine Deus	88
7b. Qui tollis	96
8. Qui sedes	102
9a. Quoniam tu solus sanctus	108
9b. Cum Sancto Spiritu	116
II. Symbolum Nicenum	
10. Credo in unum Deum	141
11. Patrem omnipotentem	146
12. Et in unum Dominum	155
13. Et incarnatus est	162
14. Crucifixus	166
15. Et resurrexit	170
16. Et in Spiritum Sanctum	195
17a. Confiteor	201
17b. Et expecto	206
III. Sanctus	
18a. Sanctus	222
18b. Pleni sunt coeli	234
IV. Osanna, Benedictus, Agnus Dei et Dona nobis pacem	
19. Osanna in excelsis	248
20. Benedictus	266
21. Osanna repetatur	
22. Agnus Dei	269
23. Dona nobis pacem	271
Hinweise zur Notation und Aufführungspraxis / Issues of notation and performance practice	284
Kritischer Bericht / Critical Report	292
Individual Remarks	298
Konkordanz / Concordance	302

Vorwort

Die vorliegende Neuausgabe der *Messe in h-Moll* BWV 232 von Johann Sebastian Bach beruht auf der Originalpartitur, die heute in der Staatsbibliothek zu Berlin – Preußischer Kulturbesitz aufbewahrt wird (Quelle **A**), und auf den beiden ältesten Abschriften aus der Zeit um 1765/1770 (Quellen **C** und **D**). Für die Sätze Kyrie und Gloria wurde der Originalstimmensatz von 1733, dessen Anfertigung Johann Sebastian Bach überwachte und in großen Teilen auch selber schrieb, als Hauptquelle herangezogen (Staats- und Universitätsbibliothek – Sächsische Landesbibliothek Dresden, Quelle **B**). Als Hybrid-Edition werden diese Quellen auf der zugehörigen DVD nicht nur vollständig im Faksimile wiedergegeben, sondern dort sowohl mit der Edition als auch mit dem Kritischen Bericht verknüpft. Hierdurch kann der Kritische Bericht in der gedruckten Partitur auf eine Beschreibung der Quellen und der wesentlichen Textvarianten beschränkt werden. Dem Kritischen Bericht vorangestellt sind aber Hinweise zur Aufführungspraxis, die Besonderheiten der Notation erläutern, sofern sie auf die Aufführungspraxis Einfluss haben können.

Entstehungshintergrund

Die Idee des autonomen Kunstwerks, die die Diskussion von Kunst seit dem 19. Jahrhundert bestimmt, war Johann Sebastian Bach und seinen Zeitgenossen fremd. Noch sein Sohn Carl Philipp Emanuel bekannte als fast 60jähriger in seiner Autobiographie: „Unter allen meinen Arbeiten, besonders fürs Clavier, sind blos einige Trios, Solos und Concerte, welche ich mit aller Freyheit und zu meinem eignen Gebrauch gemacht habe.“¹ Nahezu alle Werke eines Johann Sebastian Bach sind somit auf äußere Veranlassung hin entstanden, sei es aus seinen Dienstpflichten als Konzert- und Kapellmeister oder aus der Notwendigkeit des Unterrichts heraus. Bemerkenswert ist aber, dass Johann Sebastian Bach sich mit einigen Werken über größere Zeiträume immer wieder auseinandergesetzt hat. Die Eingriffe, die er dabei vornahm, gingen dabei zum Teil deutlich darüber hinaus, was für eine bloße Wiederaufführung notwendig gewesen wäre, und lassen ein Bemühen erkennen, eine „endgültige“ Werkgestalt zu schaffen. Besonders deutlich zeigt sich dies beispielsweise bei der *Matthäus-Passion* BWV 244, für die Bach – wahrscheinlich in Vorbereitung der Wiederaufführung von 1736 – eine Reinschrift anfertigte und diese später sorgfältig restaurierte, als die ersten Bogen der Handschrift beschädigt worden waren.

Noch komplexer sind die Verhältnisse bei der *h-Moll-Messe* BWV 232, wie wir sie heute nennen (Carl Philipp Emanuel Bach nannte sie in Abgrenzung von den Kyrie-Gloria-Messen BWV 233–236 „die große catholische Messe“), denn ihre Entstehungsgeschichte erstreckt sich über einen Zeitraum von mehr als 15 Jahren, und das Werk war zum Zeitpunkt des Todes von Johann Sebastian Bach am 28. Juli 1750 zwar fertiggestellt, doch fehlte eine letzte Revision, die das Werk in einen aufführbaren Zustand überführt hätte. Entgegen Spekulationen, die immer wieder hervorgebracht werden, machen es die vielen kleinen Lücken in der Textunterlegung des Autographs unwahrscheinlich, dass unter Bachs Aufsicht ein Stimmensatz angefertigt worden ist, der für eine Aufführung zu Leb-

zeiten des kränkenden Thomaskantors hätte verwendet werden können. Bach selbst hat also nach gegenwärtigem Kenntnisstand die *h-Moll-Messe* als Ganze und wahrscheinlich auch die meisten ihrer Teilsätze nie gehört. Lediglich vom Sanctus BWV 232^{III} ist bekannt, dass Bach es selbst in seiner ursprünglichen Gestalt ab 1724 mehrmals aufgeführt hat.

Werkgeschichte

Am Anfang der Werkgeschichte steht ein Auftrag, den Bach sich selbst gesetzt hatte: Nach dem Tode August des Starken am 1. Februar 1733 wollte er seinem neuen Landesherrn, Kurfürst Friedrich August II. von Sachsen (1696–1763), ein repräsentatives Werk zu-eignen. Hiermit verbunden war die Hoffnung auf einen Hoftitel, den Bach mit einiger Verzögerung, wenn auch erst auf erneutes Bitten, im November 1736 als „Compositeur bei der Hof Capelle“ auch erhielt. Das Dilemma, wie sich ein protestantischer Kirchenmusiker seinem katholischen Landesherrn präsentieren konnte, hatte Bach diplomatisch gelöst: Die lateinische Missa, bestehend aus Kyrie und Gloria, gehörte dem Ritus beider christlicher Kirchen an. Die besonderen Ambitionen des Werkes unterstrich Bach nicht nur durch seine ausgedehnten zeitlichen Dimensionen, sondern auch durch die üppige Besetzung mit einem fünfstimmigen Chor und einem vielfältigen, farbenprächtigen Instrumentarium. Die außerordentlichen musikalischen Anforderungen des Werkes werden auch heute noch spätestens beim Hornsolo des „Quoniam“ jedem Zuhörer deutlich. Bezeichnenderweise hat Bach dem sächsischen Hof keine Partitur, sondern einen Stimmensatz übersandt. Das Werk sollte also durch eine Aufführung beurteilt werden, und nicht nur durch einen Blick in die Partitur. Da es sich bei der Widmung der Missa von 1733 um ein privates Unterfangen handelte, konnte Bach die Kopisten der Thomasschule nicht heranziehen. Johann Sebastian Bach schrieb große Teile des Stimmensatzes selbst, die übrigen Kopierarbeiten übernahmen meist Familienangehörige, vor allem seine Frau Anna Magdalena und die älteren Söhne Wilhelm Friedemann und Carl Philipp Emanuel. Zwar hat Bach üblicherweise erst mit der Anfertigung und Durchsicht des Stimmensatzes ein Werk aufführungspraktisch genau fixiert; Angaben zur Artikulation und Dynamik finden sich in den Originalpartituren auch sonst nur spärlich. Die *Missa in h*, die später zur *h-Moll-Messe* erweitert wurde, unterscheidet sich aber durch den hohen Eigenanteil Johann Sebastian Bachs bei der Erstellung des Stimmensatzes deutlich von der sonst üblichen Praxis: Ohne Zuhilfenahme der Originalstimmen wären Bachs Vorstellungen über die Verwendung der Flöten und Fagotte, die in der Partitur weitgehend keine eigenen Systeme erhalten haben, nicht rekonstruierbar. Beim Abschreiben hat Bach, ohne dies in seiner Partitur zu vermerken, auch öfters in die Melodieführung eingegriffen, so dass der Dresdner Stimmensatz gegenüber der Originalpartitur eine ungewöhnlich weitreichende Revision darstellt.

¹ Carl Philipp Emanuel Bach, Autobiographie, in: *Carl Burney's der Musik Doctors Tagebuch seiner Musikalischen Reisen*, Dritter Band, Hamburg 1773, S. 198–209, hier S. 209.

In seinen letzten Lebensjahren, wahrscheinlich ab 1748, hat sich Bach die Partitur der Kyrie-Gloria-Messe noch einmal vorgenommen und sie aus bis heute ungeklärtem Anlass durch Hinzufügung des Credo, Sanctus (mit Osanna), Benedictus und Agnus Dei zu einer *Missa tota* erweitert. Dabei hat sich Bach weitgehend eines kompilierenden Verfahrens bedient und die Mehrzahl der Sätze aus älteren Kompositionen übernommen: Das sechsstimmige Sanctus war bereits 1724 entstanden, und die Mehrzahl der Einzelsätze stammt (wie in den Kyrie-Gloria-Messen BWV 233–236 in den späten 1730er-Jahren erfolgreich erprobt) aus eigenen Kirchenkantaten, denen durch Parodie neue lateinische statt der ursprünglichen deutschen Texte unterlegt wurden. Die Vorlagen für die einzelnen Sätze werden im Kritischen Bericht nachgewiesen. Offenbar ging es Bach dabei nicht in erster Linie um Arbeitersparnis, denn er nahm weitreichende Anpassungen gegenüber den Vorlagen vor, die über das unbedingt Erforderliche deutlich hinausgehen. Vielmehr scheint Bach idealtypische Sätze, die das ganze Spektrum seiner Kunst und seiner künstlerischen Entwicklung seit der Weimarer Zeit umfassen, zu einer Einheit zusammengestellt zu haben. Der retrospektive Charakter, der sich in Bachs letztem Lebensjahrzehnt auch sonst beobachten lässt, wird auch aus der Verwendung von Sätzen im *Stile antico*, etwa bei der Credo-Intonation, deutlich. In einem letzten Revisionsschritt entschied er sich, den Abschnitt „Et incarnatus est“, der zuvor in das „Et in unum Dominum“ integriert war, herauszulösen und durch eine Neukomposition zu ersetzen. Auf diese Weise stehen in der *h-Moll-Messe* der älteste Teilsatz „Crucifixus“, der auf dem Eingangschor der Kantate *Weinen, Klagen, Sorgen, Zagen* BWV 12 von 1714 beruht, und die mutmaßlich späteste Vokalkomposition Johann Sebastian Bachs unmittelbar nebeneinander. Zur Abrundung griff Bach für das „Dona nobis pacem“ auf einen Satz aus dem ersten Teil des Werkes (hier das „Gratias agimus tibi“) zurück, ein Verfahren, das in der Messkomposition häufig anzutreffen ist. Im Zuge der Erweiterung des Werkes zur *Missa tota* nahm Bach auch an Kyrie und Gloria kleinere Veränderungen vor. Dabei handelt es sich überwiegend um Detailkorrekturen an der Textunterlegung sowie um melodische Korrekturen an den Vokalstimmen, die teilweise dazu dienen sollten, parallele Quinten und Oktaven, die im fünfstimmigen Vokalsatz fast unvermeidbar sind, zu eliminieren. Nur im „Quoniam“ hat Bach die solistische Bassstimme deutlich, in fast einem Fünftel der Vokaltakte, revidiert.

Eine Besonderheit der *h-Moll-Messe*, die ebenfalls bis heute nicht schlüssig erklärt ist, ist die Verwendung des Nicenischen Glaubensbekenntnisses (*Symbolum Nicenum*) anstelle des üblichen Apostolischen Glaubensbekenntnis im Credo. Durch das *Symbolum Nicenum* und die ungewöhnliche zeitliche Ausdehnung wird ein liturgischer Gebrauch der *h-Moll-Messe* zwar stark eingeschränkt, aber nicht vollständig ausgeschlossen: Messen mit außergewöhnlichem Umfang und besonderen Anforderungen sind im späten 18. und frühen 19. Jahrhundert auch sonst gelegentlich anzutreffen. Zu denken ist beispielsweise an Mozarts (unvollendete) *c-Moll-Messe* KV 427, Haydns *Missa Cellensis* Hob. XXII:5 oder Beethovens *Missa solemnis* op. 123.

Überlieferungsgeschichte

Nach Bachs Tod gelangte das Autograph an Carl Philipp Emanuel Bach, der die Handschrift nicht nur verwahrte, sondern sich aktiv um die Verbreitung der *h-Moll-Messe* kümmerte. Um 1765 überließ der Bach-Sohn seinem engen Freund Johann Friedrich Hering (1724–1810), Klavierlehrer und Musiker im Dienst der Grafen von Voß-Buch, das Partiturotograph zur Abschrift. Eine ungünstige

Konstellation aus schlechter Papierqualität und einer aggressiven Tinte, verbunden mit zahlreichen Korrekturen, die den Tintenauftrag erhöhten, hatte schon zu dieser Zeit die Lesbarkeit der Handschrift stark beeinträchtigt. Hering sparte beim Abschreiben jene Stellen aus, die er nicht sicher entziffern konnte; Carl Philipp Emanuel Bach trug die entsprechenden Stellen in Herings Abschrift (Quelle **C**) nach und besserte dabei zugleich die autographe Partitur aus, wobei er fehlende Textworte nachtrug, undeutliche Lesarten überschrieb oder durch Tonbuchstaben verdeutlichte, aber auch an einigen Stellen radierte und Verbesserungen nach eigenem Gutdünken vornahm. Wenige Jahre später, wahrscheinlich 1769 – Carl Philipp Emanuel war inzwischen nach Hamburg übersiedelt, wo er die Nachfolge seines Taufpaten Georg Philipp Telemann als Hamburgischer Musikdirektor übernommen hatte – ließ sich Johann Philipp Kirnberger (1721–1783) in Berlin die Originalpartitur aus, um eine weitere, sehr sorgfältige Kopie anfertigen zu lassen (Quelle **D**). Die beiden Abschriften aus Herings und Kirnbergers Besitz spiegeln den Zustand der Bach'schen Originalpartitur vor 1770 wieder; sie dokumentieren den ältesten Zustand dieser Quelle, der durchgehend rekonstruierbar ist, allerdings – wie erst in den letzten Jahren deutlich geworden ist – gegenüber der durch Johann Sebastian Bach 1750 hinterlassenen Werkgestalt in Einzelheiten durch Carl Philipp Emanuel bereits verändert worden war.

Während seiner Hamburger Zeit ab 1768 hat sich der Bach-Sohn mehrfach mit der *h-Moll-Messe* seines Vaters auseinandergesetzt. Er machte den englischen Musikforscher Charles Burney (1726–1814) bei dessen Besuch in Hamburg auf die Komposition aufmerksam und ließ für ihn durch seinen Hauptkopisten Johann Heinrich Michel (um 1750–1810) eine Abschrift des *Symbolum Nicenum* anfertigen (wohl Staatsbibliothek zu Berlin, Signatur: *Mus. ms. Bach P 1212*). Das Credo der Messe führte er am 9. April 1786 in einem Benefizkonzert für das hamburgische Armeninstitut mit Ausschnitten aus Händels *Messias* und eigenen repräsentativen Werken auf. Hierfür richtete der Hamburger Bach die Originalpartitur des Credo gründlich ein: Er ergänzte die Generalbassbezeichnung, die sein Vater nur in den Anfangstakten notiert hatte, trug zahlreiche Artikulationsangaben, Bögen, seltener Artikulationspunkte und dynamische Bezeichnungen sowie vereinzelt auch Ornamente wie Triller und Vorschläge nach. An einigen Stellen griff er wohl aus ästhetischen Gründen stärker in den Notentext, insbesondere die Deklamation, und in die Instrumentation ein, als unbedingt erforderlich gewesen wäre. Für diese Fassung des Credo stellte der Bach-Sohn dem Satz zusätzlich eine kurze instrumentale Einleitung voran, die auch im *Verzeichnis des musikalischen Nachlasses des verstorbenen Capellmeisters Carl Philipp Emanuel Bach*² in der Kategorie „Einige vermischte Stücke“ als „Einleitung zu Joh. Sebast. Bachs *Credo*.“ nachgewiesen ist. Carl Philipp Emanuel Bachs spätere Eintragungen aus der Zeit um 1786 unterscheiden sich im Schriftduktus von denen der 1760er-Jahre. Zwar ist aufgrund ihrer Kürze und dem fortschreitenden Papierzerfall eine zeitliche Zuordnung nicht immer mit Sicherheit möglich, doch können die Korrekturschichten durch Zuhilfenahme der erwähnten Abschriften aus dem Besitz von Hering und Kirnberger zuverlässig voneinander getrennt werden. Da diese beiden Abschriften, unter denen sich die Abschrift für Kirnberger (Quelle **D**) als etwas zuverlässiger erweist, unabhängig voneinander entstanden sind, ist davon auszugehen, dass Carl Philipp Emanuel Bach Änderungen an

² Hamburg: Schniebes, 1790, S. 66.

solchen Stellen, wo die beiden Abschriften noch die frühere Lesart zeigen, erst in seiner Hamburger Zeit vorgenommen hat.

Angesichts des großen musikalischen und technischen Anspruchs, der ebenso wie das Fehlen geeigneter Konzertformate eine Aufführung in der zweiten Hälfte des 18. Jahrhunderts nahezu unmöglich machte, muss die große Zahl an Abschriften, die bis zum Erscheinen des Erstdrucks angefertigt wurden, überraschen. Insgesamt sind fast 20 weitgehend vollständige Partiturabschriften des Werkes bekannt, die sich zum größeren Teil auf Kirnbergers Abschrift zurückführen lassen, zum kleineren auf das Autograph zurückgehen, das 1805 über Carl Philipp Emanuel Bachs Amtsnachfolger Christian Friedrich Gottlob Schwencke an den Züricher Musikverleger Hans Georg Nägeli verkauft worden war. Hinzu kommen mehrere Teilkopien, die das Symbolum Nicenum enthalten und die ihrerseits überwiegend auf die Burney schon vor der Revision von 1786 überlassene Abschrift zurückgehen.

Die Drucklegung der *h-Moll-Messe*, die der Züricher Verleger Hans Georg Nägeli als zeitweiliger Besitzer des Autographs als „größtes Kunstwerk aller Zeiten und Völker“ 1818 ankündigte, gestaltete sich schwierig. Während Kyrie und Gloria 1833 gedruckt wurden, kam es wegen geringer Subskribentenzahlen erst 1845 zur Veröffentlichung des zweiten Teils der Messe. Die Herausgeber der *Bach-Gesamtausgabe* konnten Nägelis Sohn Hermann nicht dazu überreden, ihnen Einsicht in das Autograph zu gestatten, so dass die Edition in Band 6 der Ausgabe (1856) auf der Basis von Abschriften, darunter auch dem Originalstimmensatz von Kyrie und Gloria aus Dresden erfolgen musste. Schließlich konnte das Autograph doch von der Bach-Gesellschaft angekauft werden, was eine revidierte Neuauflage des zweiten Teils der Messe im Jahre 1857 zur Folge hatte. In der *Neuen Bach-Ausgabe* ist die *h-Moll-Messe* als einer der ersten Bände, herausgegeben von Friedrich Smend, bereits 1954 erschienen (NBA II/1); methodische Mängel der Ausgabe, die zum Teil bei Erscheinen der Ausgabe nicht absehbar waren, machten eine Neuauflage im Rahmen der *Neuen Bach-Ausgabe – Revidierte Edition*, herausgegeben vom Bach-Archiv Leipzig (Kassel u.a. 2010; NBA rev 1) erforderlich. Uwe Wolf konnte als Herausgeber erstmals die Ergebnisse einer Röntgenfluoreszenzanalyse nutzen, bei der durch punktuelle Materialprüfungen Eintragungen von Carl Philipp Emanuel Bach und Johann Sebastian Bach meist zweifelsfrei voneinander unterschieden werden konnten. Wissenschaftliche Neuauflagen haben in den letzten beiden Jahrzehnten auch Christoph Wolff (Frankfurt, New York 1997) und Joshua Rifkin (Wiesbaden 2006) vorgelegt. Die *Missa* (Kyrie und Gloria) ist bislang nur ein einziges Mal wissenschaftlich ediert worden.³

Zur Edition

Die komplizierte Entstehungs- und Überlieferungsgeschichte der *h-Moll-Messe* bringt es mit sich, dass von einer verbindlichen Werkgestalt gar nicht gesprochen werden kann. Zwar bildet die autographe Partitur die wichtigste Quelle, die das Werk als Ganzes umfasst, doch enthält sie spätere Eintragungen, die nur durch den Vergleich mit den ältesten Abschriften eliminiert werden können. Wie oben beschrieben ist es unmöglich, den genauen Zustand der Handschrift bei Bachs Tod zu rekonstruieren. Selbst wenn dies gelänge, wären Eingriffe in Bachs Original notwendig, da der zweite Teil der Messe bedingt durch Bachs schlechten Gesundheitszustand nicht in allen Details ausgearbeitet war. Wir müssen darauf vertrauen, dass Bachs Sohn Carl Philipp Emanuel seine Änderungen in der Berliner Zeit mit großer Pietät und aus zeitlicher Nähe und guter

Kenntnis des väterlichen Stils vorgenommen und auf das Nötigste beschränkt hat. Die Einrichtung des Credo von 1786 für ein Hamburger Benefizkonzert bedeutet hingegen eine aufführungspraktische Einrichtung, die in erster Linie rezeptionsgeschichtliche Aufmerksamkeit beanspruchen kann, aber keine Rückschlüsse für die Aufführungspraxis unter Johann Sebastian Bach selbst erlaubt. Für die Sätze vom Credo bis zum „Dona nobis pacem“ bildet somit die Originalpartitur die entscheidende Quelle, wobei die beiden frühen Abschriften **C** und **D** zu Kontrollzwecken herangezogen werden. Dies gilt nicht nur für die von Carl Philipp Emanuel Bach vorgenommenen Änderungen, sondern auch für alle Stellen, an denen das Autograph unlesbar oder durch Tintenfraß zerstört ist. Obwohl das Autograph in seinem heutigen Zustand in exzellenten Scans im Rahmen des Projekts *Bach Digital* (bachdigital.de) und zudem durch eine gute Faksimileausgabe⁴ dokumentiert ist, war es an vielen Stellen hilfreich, die älteste Faksimileausgabe von 1924 (Leipzig: Insel-Verlag) heranzuziehen, da der irreversible Papierzerfall, der vor einigen Jahren durch konservatorische Behandlung gestoppt werden konnte, zu diesem Zeitpunkt noch wesentlich weniger stark ausgeprägt war.

Für den ersten Teil der Messe war eine Grundsatzentscheidung zu treffen. Allen bisherigen Ausgaben liegt das Partiturotograph als Hauptquelle zu Grunde, das allerdings wie oben beschrieben wesentlich weniger Informationen enthält als der Dresdner Originalstimmensatz. Folgerichtig wurden die Originalstimmen stets zusätzlich herangezogen, um fragliche Aspekte, insbesondere der Instrumentation, zu klären. Dies führt allerdings unvermeidlich zu einer Quellenmischung, da zwar die späteren Änderungen Bachs im Autograph berücksichtigt wurden, von den vielen Detailkorrekturen der Stimmen aber nur eine stets willkürliche Auswahl übernommen wurde. In der vorliegenden Ausgabe wurden für den ersten Teil der Messe hingegen die von Bach bis ins Detail fixierten Lesarten der Dresdner Originalstimmen als Haupttext angesehen; die vergleichsweise wenigen späteren autographen Änderungen sind in den Einzelanmerkungen des Kritischen Berichts übersichtlich zusammengefasst. Nur im „Quoniam“ schien es angesichts der grundlegenden Revision der Singstimme sinnvoll, Bachs späte und durch die bisherigen Ausgaben vertraute Revision als Ossia-System unmittelbar kenntlich zu machen. Durch diese konsequente Trennung bietet die Neuauflage auch die Möglichkeit, die bislang in der musikalischen Praxis gänzlich vernachlässigte Dresdner Fassung des Werkes von 1733 als eine Kyrie-Gloria-Messe separat aufzuführen.

Die vorliegende Neuauflage wäre nicht möglich gewesen ohne das Entgegenkommen der Staatsbibliothek zu Berlin – Preußischer Kulturbesitz und der Staats- und Universitätsbibliothek – Sächsische Landesbibliothek Dresden, die nicht nur die Quellen für die Edition bereitgestellt, sondern auch die Genehmigung zur digitalen Faksimilierung erteilt haben. Auch der Verlag hat der Edition größte Aufmerksamkeit gewidmet und alle Wünsche des Herausgebers bereitwillig unterstützt. Nicht zuletzt sei dem EDIROM-Team (www.edirom.de; Universität Paderborn/Hochschule für Musik Detmold) für seine Unterstützung herzlich gedankt.

Salzburg, im Februar 2014

Ulrich Leisinger

³ *Frühfassungen zur h-Moll-Messe BWV 232*, hrsg. von Uwe Wolf, NBA II/1a, Kassel u.a. 2005.

⁴ *Johann Sebastian Bach. Messe in h-Moll BWV 232 mit Sanctus BWV 232^{III}. Faksimile der autographen Partitur in der Staatsbibliothek zu Berlin*, hrsg. von Christoph Wolff, Kassel u.a. 2007.

Foreword

This new edition of Johann Sebastian Bach's *Mass in B minor* BWV 232 is based on the original score, located today in the Staatsbibliothek zu Berlin – Preussischer Kulturbesitz (source **A**), and on the two earliest copyists' manuscripts, dating roughly between 1765 and 1770 (sources **C** and **D**). For the Kyrie and Gloria the original set of parts, dating from 1733 and located in the Staats- und Universitätsbibliothek – Sächsische Landesbibliothek in Dresden, was consulted as a primary source (source **B**). Its preparation was supervised by Bach himself, and large sections of it are in his hand. This being a hybrid edition, these sources are not only reproduced in complete facsimile on the accompanying DVD, but are also linked there with the edition and the Critical Report. This makes it possible to limit the Critical Report in the printed score to a description of the sources and major textual variants. However, issues of performance practice, which explain peculiarities of notation insofar as they affect performance, precede the Critical Report in a separate section.

Background and Genesis

The idea of an autonomous work of art that has governed discussions of art ever since the nineteenth century was alien to Johann Sebastian Bach and his contemporaries. Even his son Carl Philipp Emanuel, then almost sixty years old, admitted in his autobiography that "of all my works, especially those for keyboard, there are only a few trios, solos, and concertos which I composed with complete freedom and for my own use."¹ Practically all of the works of Johann Sebastian Bach were thus written for external occasions, whether in fulfillment of his duties as concert- and chapel-master or to meet the needs of his lessons. Remarkably, however, he returned to some of his works again and again over long periods of time. Some of the alterations he made went far beyond what was necessary for a simple revival, suggesting that he was intent on putting these works into a "definitive" shape. This is especially noticeable, for example, in the *St. Matthew Passion* BWV 244, for which Bach, probably in preparation for the 1736 revival, prepared a fair copy and later carefully restored it when the first sheets of the manuscript became damaged.

Still more complex are the circumstances surrounding the *B-minor Mass* BWV 232, to use the name we give it today (Carl Philipp Emanuel Bach called it "the great Catholic Mass" to distinguish it from his father's Kyrie-Gloria Masses, BWV 233–236). Its genesis was spread over a period of more than fifteen years, and the work, though finished at the time of Bach's death (on 28 July 1750), still awaited a final revision to put it into performable condition. Despite frequently heard speculations to the contrary, the many small gaps in the textual underlay of the autograph make it unlikely that Bach oversaw the preparation of a set of parts that might have been used in a performance during the ailing composer's lifetime. In other words Bach himself, as far as we can tell today, never heard the *B-minor Mass* in its entirety, and probably not even the majority of its movements. Only the Sanctus BWV 232^{III} in its original form is known to have been performed several times since 1724 under his direction.

History of the Work

The history of the *B-minor Mass* begins with a task that Bach took upon himself. After the death of August the Strong on 1 February 1733, he wanted to dedicate a lavish work to his new sovereign, Prince-Elector Frederick August II of Saxony (1696–1763). Connected with this task was his hope of receiving a court title, which was indeed, after a renewed petition, belatedly bestowed upon him in November 1736, when he was named "Compositeur bei der Hof Capelle." He had found a diplomatic solution to the dilemma imposed on a Protestant church musician confronted with a Catholic sovereign: the Latin *Missa*, consisting of Kyrie and Gloria, belonged to the rites of both Christian denominations. Bach emphasized the work's special ambitions not only with its great length, but also with its luxuriant scoring for five-voice chorus and brilliant, multifarious instrumentation. Even today its extraordinary musical demands are patently evident at the very least in the horn solo of the "Quoniam." Revealingly, he sent the work to the Saxon court in a set of parts rather than a full score. In other words, the work was meant to be judged in performance, not by a perusal of the score. As the dedication of the 1733 *Missa* was a private matter, Bach was unable to avail himself of the copyists at St. Thomas's. He wrote out large sections of the parts himself and parceled out the remaining copying work mostly to members of his family, especially his wife Anna Magdalena and his eldest sons, Wilhelm Friedemann and Carl Philipp Emanuel. True, it was usually only when he wrote out and checked through the parts that he finalized a work in performable form; instructions regarding articulation and dynamics are otherwise only found sporadically in his original scores. However, the *Missa in B*, later expanded into the *B-minor Mass*, differs markedly from his usual practice in that he wrote out a large portion of the parts himself: his ideas regarding the use of the flutes and bassoons, which for the most part were not given separate staves in the full score, cannot be reconstructed without the aid of the original parts. When Bach wrote out the parts, he often altered the melodic writing without transferring the alterations into the score. As a result, the Dresden set of parts represents an unusually far-reaching revision of the original score.

In the final years of his life, probably beginning in 1748, Bach again took the score of the Kyrie-Gloria Mass in hand and, for reasons still unknown today, expanded it into a *Missa tota* by adding the Credo, Sanctus (with Osanna), Benedictus, and Agnus Dei. He did so largely by compiling the bulk of the movements from earlier compositions: the six-voice Sanctus had already been composed in 1724, and most of the separate movements (successfully tried out in the late 1730s, as were the Kyrie-Gloria Masses BWV 233–236) were borrowed from his own church cantatas, with the original German words now replaced by new Latin texts in a process

¹ Translated from: Carl Philipp Emanuel Bach, *Autobiography*, in: *Carl Burney's der Musik Doctors Tagebuch seiner Musikalischen Reisen*, vol. 3, Hamburg, 1773, pp. 198–209, quote on p. 209.

known as parody. The original works exploited for these movements are listed in the Critical Report. Evidently Bach's primary concern was not to reduce the amount of labor involved, for he also made far-reaching changes to the originals that went well beyond what was absolutely necessary. Rather, he seems to have gathered together archetypical movements encompassing the full spectrum of his art and his artistic evolution since his days in Weimar. This retrospective character (a quality also noticeable elsewhere in the final decade of his life) is apparent in his use of movements in the *stile antico*, e.g., in the intonation of the Credo. In a final stage of revision, he then decided to extract the "Et incarnatus est," which had previously formed part of the "Et in unum Dominum," and to replace it with a new composition. In this way the earliest movement of the *B-minor Mass*, the "Crucifixus" (based on the opening chorus of the 1714 cantata *Weinen, Klagen, Sorgen, Zagen* BWV 12) came to stand side by side with what is presumably Bach's very last vocal composition. To round off the work with the "Dona nobis pacem," Bach turned to a movement from the work's first section, the "Gratias agimus tibi" – a procedure frequently encountered in settings of the Mass. In expanding the work into a *Missa tota*, he also made minor alterations to the Kyrie and Gloria. Most of them had to do with details in the textual underlay and melodic corrections in the vocal parts, partly to eliminate parallel fifths and octaves, which are practically unavoidable in five-voice textures. Only in the "Quoniam" did he clearly revise the solo bass part, altering almost a fifth of its measures. One peculiarity of the *B-minor Mass* that continues to elude logical explanation is Bach's use of the Nicene Creed (*Symbolum Nicenum*) in the Credo in lieu of the standard Apostles' Creed. The *Symbolum Nicenum* and the unusually long duration of the *B-minor Mass* severely limit its liturgical use. However, this use is not precluded altogether: Mass settings of unusual length and special requirements can occasionally be found elsewhere in the late eighteenth and early nineteenth centuries. We need only think of Mozart's (incomplete) *C-minor Mass* K. 427, Haydn's *Missa Cellensis* Hob. XXII:5, or Beethoven's *Missa solemnis* op. 123.

Source History

After Bach's death, the autograph score of the *B-minor Mass* passed to Carl Philipp Emanuel Bach, who not only preserved the manuscript but actively took part in the work's dissemination. Some time around 1765 he gave the autograph for copying purposes to his close friend Johann Friedrich Hering (1724–1810), a teacher of keyboard instruments and musician in the service of the Counts of Voss-Buch. By this time an unfortunate combination of poor paper quality and aggressive ink, together with many alterations that increased the amount of ink applied, had already seriously damaged the manuscript's legibility. While writing out his copy, Hering omitted those passages he was unable to decipher. Carl Philipp Emanuel Bach later entered them into Hering's manuscript (source C) and made improvements to the autograph score, entering missing words in the text, overwriting indistinct passages, and clarifying pitches with letter notation. But he also made erasures in several passages and entered improvements as he saw fit. A few years later, probably in 1769 (Carl Philipp Emanuel had by then moved to Hamburg to succeed his godfather Georg Philipp Telemann as the city's music director), Johann Philipp Kirnberger (1721–1783) in Berlin borrowed the original score in order to prepare another, very meticulous copy (source D). The two copies from Hering's and Kirnberger's possessions reflect the state of Bach's original score prior to 1770. They document the earliest

state of this source which can be securely reconstructed, although, as has recently become clear, Carl Philipp Emanuel had already altered details in the work as left behind by his father in 1750.

During his years in Hamburg (from 1768), Carl Philipp Emanuel examined his father's *B-minor Mass* several times. He drew it to the attention of the English musical scholar Charles Burney (1726–1814) during the latter's visit to Hamburg and had a copy of the *Symbolum Nicenum* (probably *Mus. ms. Bach P 1212* in the Berlin Staatsbibliothek) written out for Burney by his principal copyist Johann Heinrich Michel (ca. 1750–1810). On 9 April 1786, he performed the Credo as part of a benefit concert for Hamburg's almshouse, along with excerpts from Handel's *Messiah* and a few representative works of his own. To do this, he thoroughly arranged the original score of the Credo, adding numbers to the figured bass (his father had written them only in the opening bars) and inserting articulation instructions, slurs, a few articulation dots, dynamic marks, and occasionally ornaments such as trills and appoggiaturas. In some passages, probably for aesthetic reasons, he altered the musical text more intensively than was absolutely necessary, particularly as regards the declamation, and the instrumentation. For this version of the Credo he prefaced the movement with a brief instrumental introduction, listed as "Introduction to Johann Sebastian Bach's Credo" under the heading "Some Miscellaneous Pieces" in the inventory of his musical estate.² The entries Carl Philipp Emanuel made later, in or around 1786, differ from those of the 1760s in their handwriting. Admittedly, owing to their brevity and the ongoing disintegration of the paper, they cannot always be dated with absolute certainty; but the layers of correction can be reliably distinguished using the aforementioned Hering and Kirnberger copies. As these two copies, of which the one for Kirnberger (source D) proves to be slightly more reliable, originated independently of each other, we may safely assume that it was not until his Hamburg period that Carl Philipp Emanuel Bach altered those passages where both copies contain earlier readings.

The great musical and technical demands of the *B-minor Mass*, not to mention the absence of suitable concert formats, made its performance barely feasible in the latter half of the eighteenth century. In this light, the large number of manuscript copies prepared before the work first appeared in print is surprising. Altogether, we know of almost twenty largely complete copies of the work in full score. Most of them can be shown to derive from Kirnberger's manuscript and only a smaller number from the autograph, which had been sold via Carl Philipp Emanuel Bach's successor Christian Friedrich Gottlob Schwencke to the Zurich music publisher Hans Georg Naegeli in 1805. There are also several partial copies containing the *Symbolum Nicenum*, derived largely from the copy given to Burney prior to the 1786 revision.

The publication of the *B-minor Mass* was announced in 1818 by the Zurich publisher Hans Georg Naegeli, the sometime owner of the autograph, who advertised it as the "greatest work of art of all ages and nations." The process proved arduous: though the Kyrie and Gloria appeared in 1833, the publication of the second part of the Mass was delayed to 1845 owing to the small number of subscribers. The editors of the Bach *Gesamtausgabe* were unable to persuade Naegeli's son Hermann to give them access to the auto-

² See: *Verzeichniß des musikalischen Nachlasses des verstorbenen Capellmeisters Carl Philipp Emanuel Bach*, Hamburg: Schniebes, 1790, p. 66.

graph score. As a result, the edition in volume 6 of the *Gesamtausgabe* (1856) had to be based on copyists' manuscripts, including the original Dresden set of parts of the Kyrie and Gloria. Finally the Bach Society was able to purchase the autograph, which necessitated a revised new edition of the second part of the Mass in 1857. The *B-minor Mass* was one of the first volumes published in the *Neue Bach-Ausgabe*, where it appeared in 1954 in an edition by Friedrich Smend (NBA II/1). The methodological shortcomings of that edition, some of which were unforeseeable at the time it appeared, made it necessary to prepare a new edition for the *Neue Bach-Ausgabe – Revidierte Edition*, edited by the Bach-Archiv in Leipzig (Kassel, 2010; NBArev 1). The volume's editor, Uwe Wolf, was able for the first time to utilize the findings of X-ray fluorescence spectroscopy, which made it possible to distinguish Carl Philipp Emanuel Bach's inscriptions from his father's by examining the material point by point, usually with incontestable results. In recent years, new scholarly editions have also been presented by Christoph Wolff (Frankfurt and New York, 1997) and Joshua Rifkin (Wiesbaden, 2006). Up to now the *Missa* (Kyrie and Gloria) has appeared only once in a scholarly edition.³

Concerning the Edition

Owing to its complex genesis and source history, the *B-minor Mass* cannot be said to exist in a definitive form. True, the autograph score is the most important source for the work as a whole, but it contains subsequent inscriptions that can only be eliminated through a comparison with the earliest copyists' manuscripts. As described above, it is impossible to reconstruct the precise state of the manuscript at the time of Bach's death. Even if this could be done, it would be necessary to intervene in Bach's original, since Bach's poor health prevented him from working out the second part of the Mass in every detail. We will have to trust that his son Carl Philipp Emanuel made his changes in the Berlin period with great reverence, close temporal proximity, and a solid knowledge of his father's style, and that he limited them to what was absolutely necessary. On the other hand, his arrangement of the Credo for a Hamburg benefit concert in 1786 involved performance markings that primarily merit the attention of reception historians but allow no conclusions to be drawn regarding performances under Johann Sebastian Bach himself. Thus, the original score forms the decisive source for the movements from the Credo to the "Dona nobis pacem," with the two early copies **C** and **D** consulted for control purposes. This applies not only to the changes undertaken by Carl Philipp Emanuel Bach, but also to all those passages where the autograph is illegible or damaged by ink corrosion. Although the autograph, in its present state, has been captured in excellent scans for the *Bach Digital* project (bachdigital.de) and has also appeared in a good facsimile edition,⁴ in many passages it was helpful to draw on the earliest facsimile edition published by Insel-Verlag of Leipzig in 1924, for the irreversible disintegration of the paper, though halted a few years ago by measures taken to preserve it, was far less advanced at that time.

A basic decision had to be made for the first part of the Mass. All previous editions have taken the autograph score as their primary source, although, as mentioned above, it contains much less information than the original Dresden set of parts. Consequently, the original parts have always been consulted to clarify uncertainties, especially in the instrumentation. This has unavoidably led to a mixture of sources, for although Bach's later changes in the autograph were taken into account, only an arbitrary selection was

made of the many detailed corrections in the parts. In our edition, by contrast, the readings set down by Bach in detail in the Dresden parts have been taken as the main text for the first part of the Mass, with the relatively few later autograph corrections succinctly summarized in the Individual Remarks of the Critical Report. Only in the "Quoniam," whose vocal part was heavily reworked, did it seem advisable to make Bach's late revision (familiar from previous editions) immediately identifiable in an *ossia* staff. By consistently observing this distinction, our new edition also enables the Dresden version of 1733 to be performed separately as a Kyrie-Gloria Mass – an option wholly neglected for performance until now.

This new edition would not have been possible without the good will of the Staatsbibliothek zu Berlin – Preussischer Kulturbesitz and the Staats- und Universitätsbibliothek – Sächsische Landesbibliothek in Dresden, both of which not only allowed access to the sources for the edition, but also granted permission for the digital facsimile. The publishers, too, have devoted great attention to the edition and willingly supported every request from its editor. Finally, we are grateful to the EDIROM team of Paderborn University and the Detmold Hochschule für Musik (www.edirom.de) for the support we received.

Salzburg, February 2014
Translation: J. Bradford Robinson

Ulrich Leisinger

³ *Frühfassungen zur h-Moll-Messe BWV 232*, ed. Uwe Wolf, NBA II/1a, Kassel, 2005.

⁴ *Johann Sebastian Bach. Messe in h-Moll BWV 232 mit Sanctus BWV 232^{III}: Facsimile der autographen Partitur in der Staatsbibliothek zu Berlin*, ed. Christoph Wolff, Kassel, 2007.

3.3. ¹² Symbolum Nicenum.

The image shows a page of handwritten musical notation. At the top left, it is numbered '3.3.' with a small '12' above it. The title 'Symbolum Nicenum.' is written in cursive. The score consists of several staves. The top staves are labeled 'Violino', 'Soprano', 'Soprano', and 'Alto'. Below these are staves for 'Tenore' and 'Basso'. There are also staves for 'Continuo', 'Organo', and 'Cello'. The vocal staves contain the Latin text: 'Cre-do in u-num De-um in unum De-um in'. The notation is dense and includes various musical symbols, clefs, and dynamics. The paper appears aged and slightly stained.

Abbildung 1

Beginn des Symbolum Nicenum in der autographen Partitur (Quelle A).

Beginning of the Symbolum Nicenum in the autograph score (source A).

Staatsbibliothek zu Berlin – Preußischer Kulturbesitz, Signatur: Mus. ms. Bach P 180.

Abbildung mit freundlicher Genehmigung.

Corne da Caccia.

ad Quoniam tu solo.

(1733)

Mus. 2405-D-21

BIBLIOTHECA MUSICA
Sächs.
Landes
Bibl. 134

Abbildung 2

Autographe Stimme „Corne da Caccia“ aus dem Stimmensatz von 1733 (Quelle B).

Autograph part "Corne da Caccia" from the set of parts of 1733 (source B).

Staats- und Universitätsbibliothek – Sächsische Landesbibliothek Dresden, Signatur: Mus. 2405-D-21.

Abbildung mit freundlicher Genehmigung.

Messe in h-Moll

Mass in B minor

BWV 232

I. Missa

Johann Sebastian Bach

1683-1750

1. Kyrie I

Adagio

Flauto traverso I

Flauto traverso II

Oboe d'amore I*

Oboe d'amore II*

Fagotto I, II

Violino I

Violino II

Viola

Soprano I

Soprano II

Alto

ri - e e - le - i - son, e - le - i - son.
le - i - son, e - le - i - son, e - le - i - son.
e - le - i - son, Ky - ri - e e - le - i - son.
Ky - ri - e, Ky - ri - e, Ky - ri - e e - le - i - son.
Ky - ri - e, Ky - ri - e, Ky - ri - e

7 6 5 6 9 8 7 6 5

* Zur Notierung der Oboen siehe "Individual Remarks". / Concerning the notation of the oboes, see "Individual Remarks."

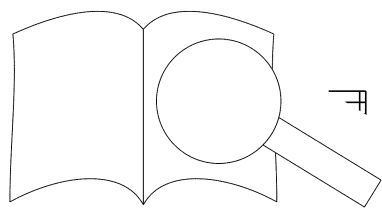

Largo

5

Fl I
Fl II
Obda I
Obda II
Fg
VI I
VI II
Va
Cont

un poco *p*
un poco *p*
un poco *p*

un poco *p* 6 6 # 6 6 6 7 3 7 3 6 4 2 6 6 6 6 6 6 6 5

10

tr
tr

6 7 9 3 7 4 6 7 3 7 6 6 6 6 6 5 6 7 6 5 6 5

15

4 3 5 \sharp 6 9 \sharp 8 7 9 8 9 8 7 9 2 6 7 6 5 8 7 6 6 7
 # # # # # # # # # # # # # # #

20

7 7 \sharp 8 7 7 \sharp 5 5 \sharp 7 7 7 9 8 7 7 4 5 6 6 4 3 6 5 7 6 7 9 6
 # # # # # # # # # # # # # # # # # # # # #

PROBENPAPIER
 Ausgabequalität gegenüber Original evtl. gemindert • Evaluation Copy - Quality may be reduced • Carus-Verlag

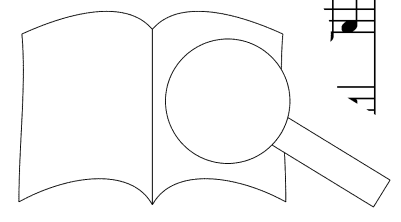

Musical score for measures 25-29. The score includes piano accompaniment in the upper and lower staves and vocal lines in the middle staves. A trill (tr) is indicated in measure 28. Fingering numbers are provided below the piano parts.

Fingering numbers for piano parts:
 Measure 25: 9 6 7 6 7 9 3 7 6 6 6 4 4 6 4 6 6 6 6 6 6
 Measure 26: 5 4 4 3 4 2
 Measure 27: 8 2 8 4 3 6 3 2

Musical score for measures 30-34. The score includes piano accompaniment and vocal lines with lyrics. A magnifying glass icon is present in the lower right corner.

Lyrics:
 -le - - - i - son, Ky-ri-e e - le - - i-son, e -
 Ky - ri - e e - le

Fingering numbers for piano parts:
 Measure 30: 5 3
 Measure 31: 6 5 # 5 6 6 6 6 6 4 4 2
 Measure 32: 6 6 4 5 4 4 6 3 7 # 6 6 6 5 6 6 5 6 7 8 7 5 6 3 4 5 7 6 5 # 4 #
 Measure 33: 3 4 2 4 2 3 3

PROBENPAPIER
 Ausgabequalität gegenüber Original evtl. gemindert • Evaluation Copy - Quality may be reduced • Carus-Verlag

PROBE PARTIUR
 Ausgabequalität gegenüber Original evtl. gemindert • Evaluation Copy - Quality may be reduced • Carus-Verlag

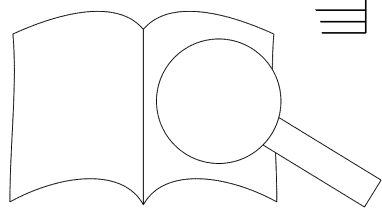

Two systems of empty musical staves, each consisting of a grand staff (treble and bass clefs).

Two systems of musical notation for piano accompaniment, featuring treble and bass clefs with various notes and rests.

Two systems of empty musical staves, each consisting of a grand staff (treble and bass clefs).

Vocal line with lyrics:

- i - son, e - le - i - son, e - le - i - son, e - le - i -

le - Ky - ri - e e - le - i - son, e - le - i -

i - e e - le - i - son, e - le - i - son, e - le - i -

i - e e - lei - son, e - le - i - son, e - le - i -

Basso continuo line with figured bass notation:

5 # 6 5 6 6 5 5 8 7 5 7 9# 6

5 # 5 3 4 3 3 5 # 5# # 4+

2

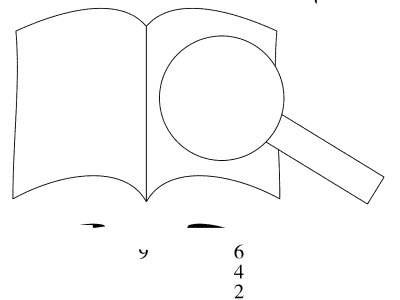

PROBE PARTIUR
 Ausgabequalität gegenüber Original evtl. gemindert • Evaluation Copy - Quality may be reduced • Carus-Verlag

son, e - le - - i - - - - i - son, e - le - - - i - son, e -

son, Ky-ri-e - - - - i - son, e - le - i - son, Ky - ri - e e - lei - -

son, e - - - - e - le - - - - i - son, e - lei - - - -

le - - - i - son, e - le - - - i - son, e - le - i - son, e - lei - -

Ky - ri - e e - le - - - - ri -

6 5 5# 7 7 4 3 7 7 6 4 3 6 5 4 3 7 6 # 5 4 3

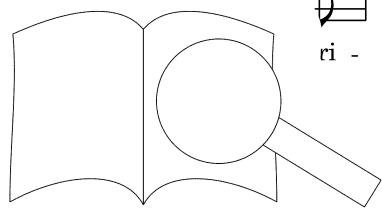

PROBEKOPPIERUNG
 Ausgabqualität gegenüber Original evtl. gemindert • Evaluation Copy - Quality may be reduced • Carus-Verlag

First system of piano accompaniment, measures 48-51. The music is in G major and 4/4 time. It features a melody in the right hand and a bass line in the left hand. Dynamics include *f* (forte) and *mf* (mezzo-forte).

Second system of piano accompaniment, measures 52-55. The music continues with similar melodic and harmonic patterns. Dynamics include *f* (forte).

Vocal line with lyrics for the first system, measures 48-51. The lyrics are: lei - - - - Ky - ri - e e - le - - - - son, Ky - ri - e e - - - i - son, Ky - ri - e e - le - - i - son, Ky - son, e - le - i - son, Ky - ri - e e - le - - i - son, e - - e e - le - i - son, Ky - ri - e e - le - i - son, e - lei - son, e - le - - i - son, e - le - i - son, e - le - i - son, e - lei -

Second system of piano accompaniment, measures 52-55. It includes a bass line with fingerings: 6, 6, 5, 6, 6, 6, 6, 7, 6, 6, 5, 6. Below the notes are numbers: 6, 4, 2, 5, 6, 4, 2, 6, 7, 5, 4, 6, 4, 3, 7, 6, 6, 5, 6.

Fingerboard diagram for the piano accompaniment, showing the right hand (RH) and left hand (LH) positions. The RH diagram shows a G major triad (G, B, D) and a G major chord (G, B, D, F#). The LH diagram shows a G major triad (G, B, D) and a G major chord (G, B, D, F#).

PROBEPAPIER
 Ausgabequalität gegenüber Original evtl. gemindert • Evaluation Copy - Quality may be reduced • Carus-Verlag

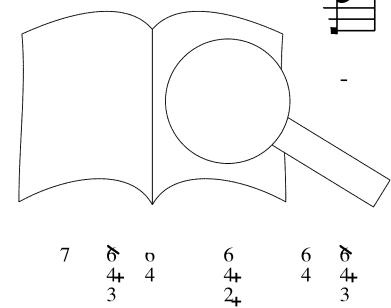

PROBENPAPIER

Ausgabequalität gegenüber Original evtl. gemindert • Evaluation Copy - Quality may be reduced • Carus-Verlag

son, Ky - ri - e e - son, e - le - i - - - son,

- i - son, e - le - i - - - son, e - le - i - -

le - - - i - son, e - le - i - son, e -

- lei - - son, e - lei - son, e - le - i - son, e - lei - son,

- le - - - - i - son, e - le - i - so.

6 # 6 6 6 5+ 6 7 6 5+ 8 7 7 8 9 8 9 # 8 7

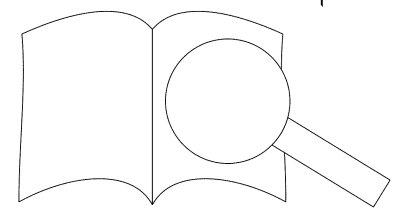

PROBE PAPIER
 Ausgabequalität gegenüber Original evtl. gemindert • Evaluation Copy - Quality may be reduced • Carus-Verlag

e - le
 - son
 e - lei -
 e - le - i - son, e - lei -
 i - son, e - lei - son, e - le - i - son, e - lei -
 e - le - i - son, Ky - ri - e e - le -

8 9 8 7 8 7 # 6 7 8 7 7# 8 7 7#

PROBE PAPIER
 Ausgabequalität gegenüber Original evtl. gemindert • Evaluation Copy - Quality may be reduced • Carus-Verlag

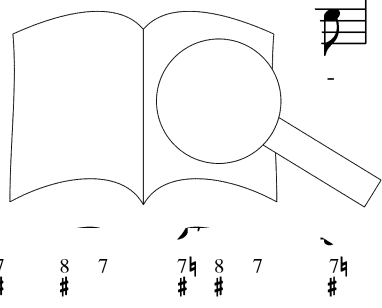

5 5# 7 7 7 9 8 7 7 6 6 5 # 6 7 9 6 7

PROBE PAPIER
 Ausgabqualität gegenüber Original evtl. gemindert • Evaluation Copy - Quality may be reduced • Carus-Verlag

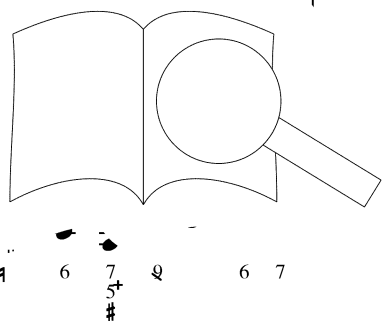

- i-son, e - le - son, Ky - ri - e e - le - le -
 le - - i - son, Ky - ri - e e - le - -
 - i-son, Ky - ri - e e - le - i-son, e - le -
 - son, e - le - - i - son, Ky - ri - e e - le - -
 - i-son, e - le - - i-son, e

PROBE

Ausgabequalität gegenüber Original evtl. gemindert • Evaluation Copy - Quality may be reduced • Carus-Verlag

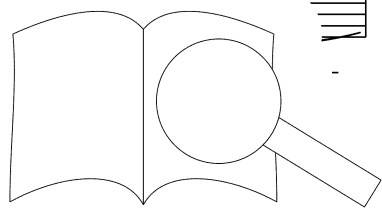

9 6 7 6 7 9 3 7 6 6 6 6 6 6 6 6 6 5 6 7 4 4 4 4 4 2 4 4 4 4 4 5 4 # 4 # 4 5 #

i - son.
i - son.
i

6 4 5 6 5 5 # 6 7 5 # 5 6 7 6 5 # 8 7 7 7 # 8 7 7 # 8 7 7 # 8 7 7 # 6 5

PROBE-PARTITUR
Ausgabequalität gegenüber Original evtl. gemindert • Evaluation Copy - Quality may be reduced • Carus-Verlag

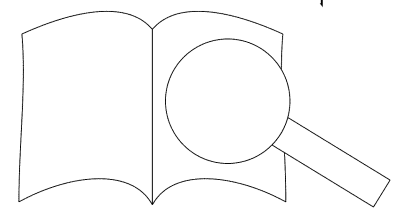

6 # 6 6 7 9 6 7 7 # 7h 7 7 7h 6 5 7 7
 5 # 5h 5 # 5 7 # 7h 7 # 4 3 #

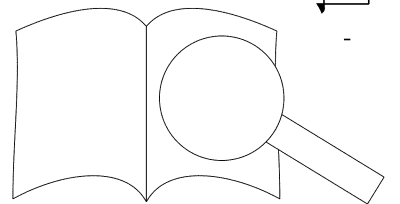

PROBENPAPIER
 Ausgabequalität gegenüber Original evtl. gemindert • Evaluation Copy - Quality may be reduced • Carus-Verlag

PROBEPARTITUR

Ausgabequalität gegenüber Original evtl. gemindert • Evaluation Copy - Quality may be reduced • Carus-Verlag

Ky - ri - e e - le - - - i - son, Ky - ri -

- - i - son, Ky - ri - e e - le - - i - son, Ky -

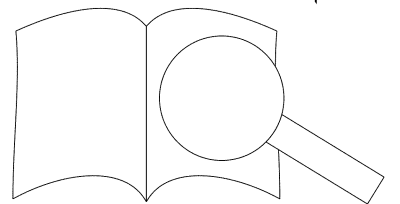

6 6 6 6 6 5 6 7 6 6 6 6 4 3 6 6 5 5 6 6 7 6 7 7 6 5⁺
5 5 5 5 4 4 4 4 2 4 2 4 2 5_h 4_h 5 # 4 #

Musical score for the first system, featuring piano accompaniment with treble and bass staves. The music is in G major and 4/4 time, consisting of two measures.

Musical score for the second system, featuring piano accompaniment with treble and bass staves. The music is in G major and 4/4 time, consisting of two measures.

Musical score for the third system, featuring piano accompaniment with treble and bass staves. The music is in G major and 4/4 time, consisting of two measures.

Musical score for the fourth system, featuring piano accompaniment and vocal line with lyrics. The lyrics are: Ky - ri - e e - le - i - son, e - le - i - son, e - le - i - son, e - le - i - son, e - le - i - son, e - le - i - son, e - le - i - s

Musical score for the fifth system, featuring piano accompaniment with treble and bass staves. The music is in G major and 4/4 time, consisting of two measures.

PROBE-PARTITUR
 Ausgabequalität gegenüber Original evtl. gemindert • Evaluation Copy - Quality may be reduced • Carus-Verlag

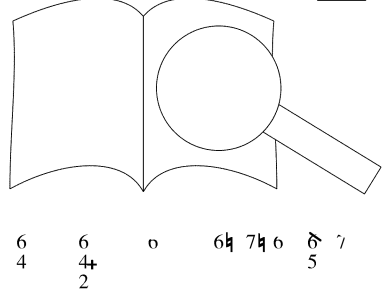

9 # 6 6 6 4+ 3 6 6 4 5 # 6 7 6 6 4 5 7 8 # 7 5 6 7 6 # 4 #

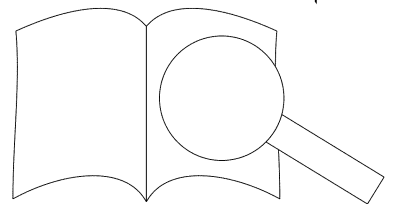

son, e - le - - i e - - i - son, e - lei - son, e - le - - i -

Ky - ri - e e - le - - -

Ay - ri - e e - le - i - son, e - le - - - - -

i - son, e - le - i - son, e - lei - - - son, Ky - ri - e e -

- lei - son, e - le - - i - son, e - le - - i -

9 8 6 6 5 7 6 5 # 4 # 5 8 7 6 6 8 7 6 6 6 6 6 6 6 6 5 #

4 # 2 4 2 6 4 2 5 4 2 5 4 2 4 2 4 2 4 2 4 2 4 2 4 2

PROBE PAPIER
 Ausgabegüte gegenüber Original evtl. gemindert • Evaluation Copy - Quality may be reduced • Carus-Verlag

Piano accompaniment for measures 98-101, featuring a treble and bass clef with a key signature of one sharp (F#).

Piano accompaniment for measures 102-105, continuing the musical texture from the previous system.

Vocal line with lyrics for measures 102-105. The lyrics are: "son, e - le - - sr - le - i - son, e - le - i - son, - e e - le - - i - son, e - le - - i - son, e - le - - i - s - - i - son, e - le - i - son, Ky - ri - e e - le - - son, e - le - - i - son, e - le - -"

Piano accompaniment and figured bass for measures 106-109. The lyrics are: "le - i - son, Ky - ri - e, Ky - ri - e e - le - i - son, e -".

Figured bass notation: 8 7 8 6 7 4# 3 6 7 7 6 6 6 6 7 6 6 5 4 7

Accidental notation: 5 4 2 # 5# 6 5 5 # 5 # 3 #

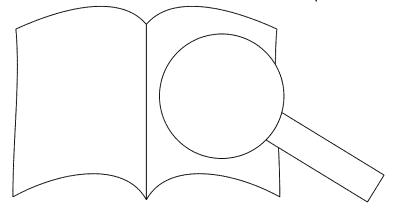

PROBEPAPIER
 Ausgabequalität gegenüber Original evtl. gemindert • Evaluation Copy - Quality may be reduced • Carus-Verlag

The musical score consists of several systems. The first three systems are piano accompaniment, each with a grand staff (treble and bass clefs). The fourth system is the vocal entry, with lyrics: "Ky - ri - e e - le - - - son, Ky - ri - e e - le - - - i - son, Ky -". The fifth system continues the vocal line: "- - i - Ky - ri - e e - le - - -". The sixth system: "e - lei - son, Ky - ri - e e - le - i - son, Ky - ri - e e -". The seventh system: "e - le - i - son, Ky - ri - e e - le - - - i - son, e -". The eighth system: "- son, Ky - ri - e e - le - i - son, e - lei -". The bottom system is a figured bass line with numbers: 7, 6, 4, #, 6, 5, 6, 6, 6h, 7, 5h, 6, #, 6, 6, 6, 5, #, 6, 4+, 2.

PROBE

Original evtl. gemindert • Evaluation Copy - Quality may be reduced • Carus-Verlag

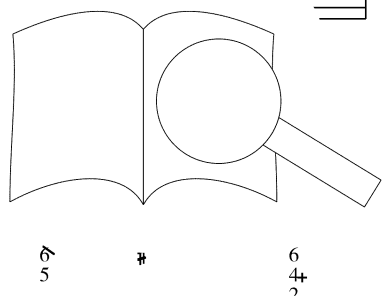

ri - e e - le - - - i - son, e - le - -
 - - - i - i - son, e - le - - - i - son, e - le - i -
 Je ri - e e - le - - - i - son, e - le - i -
 Ky - ri - e e - le - i - son, Ky - ri - e e - le - i - son, e -
 ri - e e - le - - - i - son, e - le - i -

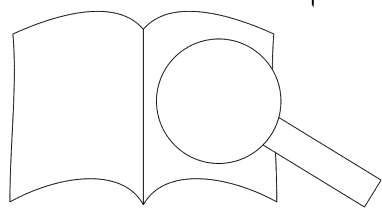

PROBENPAPIER

Ausgabequalität gegenüber Original evtl. gemindert • Evaluation Copy - Quality may be reduced • Carus-Verlag

- i-son, e - le - le - son, e - lei -
 son, Ky e - i - son, e - lei - - son,
 lei - - son, e-lei - son, e - le - i-son, e - lei - son,
 - ri - e e - le - i - son, e - le - i-son,e -
 - le - - - - i - son, e - le - i -

6 6 6 5 6 5# - 6 7# 6 5 5 7 9# 8 7 9 8 9 8 7

PROBENPAPIER
 Ausgabequalität gegenüber Original evtl. gemindert • Evaluation Copy - Quality may be reduced • Carus-Verlag

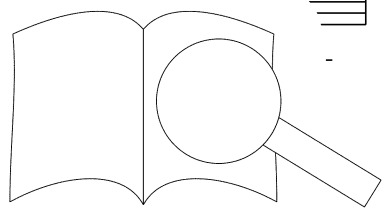

9 8 9 8 7 6 7 - 6 5 # 6 6 7 8 7 7 8 7# 7#

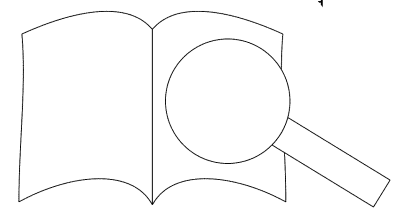

PROBE PAPIER
Ausgabequalität gegenüber Original evtl. gemindert • Evaluation Copy - Quality may be reduced • Carus-Verlag

Musical score for the first system, featuring piano accompaniment with treble and bass staves. The music is in G major and 4/4 time. The first system consists of two systems of two staves each.

Musical score for the second system, featuring piano accompaniment with treble and bass staves. The music continues from the first system.

Musical score for the third system, including vocal lines and piano accompaniment with lyrics. The lyrics are: "soi - le - i - son, e - le - i - son, e - i - son, e - le - i - son, Ky - ri - e e - lei - son, Ky - ri - e e - son, e - le - i - son, Ky - ri - e e - le - i - son, e - i - son, Ky - ri - e e - le - i".

7 7 7 7 7 7 4 5 6 7 6 5 6 5 7 6 7 9 6 7

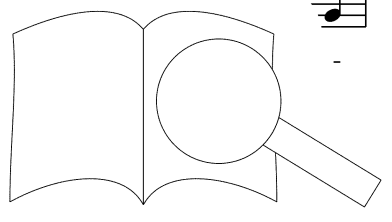

First system of piano accompaniment, measures 1-4. The music is in G major (one sharp) and 4/4 time. It features a flowing melody in the right hand and a steady bass line in the left hand.

Second system of piano accompaniment, measures 5-8. The musical texture continues with similar melodic and harmonic patterns.

Third system of piano accompaniment, measures 9-12. The accompaniment supports the vocal entries in the following system.

Vocal line with lyrics for the first system, measures 1-4. The lyrics are: le - - i-son, e - - i - ri - e e - le - - i-son, e - le - i - son.

Vocal line with lyrics for the second system, measures 5-8. The lyrics are: - i-son, e - le - - son, Ky - ri - e e - le - - i-son, e - le - i - son.

Vocal line with lyrics for the third system, measures 9-12. The lyrics are: - - i - son, Ky - ri - e e - le - - i - son.

Fourth system of piano accompaniment, measures 13-16. The music concludes with a final cadence.

PROBENPAPIER
Ausgabequalität gegenüber Original evtl. gemindert • Evaluation Copy - Quality may be reduced • Carus-Verlag

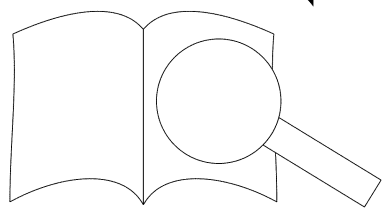

9 6 7 7 6 7 9 3 6 4 6 6 6 6 6 6 6 5 6 7 6 5 # 6 7 6 4 # 4 4 3 5 4 # 4 5 6 4 # #

2. Christe eleison

Violini unisoni

Violino I, II

Soprano I

Soprano II

Continuo

Soprano I

Soprano II

Continuo

Chri - - - ste, Chri-ste e - lei - - -

Chri - - - ste, Chri-ste e - lei - - -

13

14

a, e - lei - - - - - son,

- - son, e - lei - - - - - son,

15

le - - i-son, e - le - - i-son, e - lei - - - son, Chri -
 - ste, Chri-ste e-le - - i-son, e - le - - i-son, e - lei - - - son,

7 7 7 7 6 6 6 7 - 6 6 6 7 #
 4 5 4 3 5 #

19

- - ste, Chri-ste e - le - - i-son, e - lei - - son, Chri -
 - - ste, Chri-ste e - le - - i-son, e - lei - - son, Chri -

6 6 7 7 6 6 9 8
 4 5 5 5 4 5 4 3
 2 - 7 6 6 5

23

Chri - - ste, Chri - - ste, Chri - - ste e - le - - i-son, e - lei - - son,
 - ste, Chri-ste e - le - - i-son, e - lei - - son,

7 - 7 6 6 6 7 # 6 6 6 6 5 # 9 # 8
 4 5 4 3 5 # 4 5 3 #

27

Chri - - ste, Chri - ste e - le - - i - ;
 Chri - - ste, Chri - ste e - le - - i -

7 6 6 7 # - 6 5 6 7 7 5 6
 # 5 # 4 # 4 3 7 7 5 6
 #

PROBEKOPPIE - Evaluation Copy - Quality may be reduced - Carus-Verlag

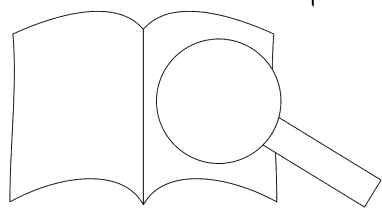

30

- i - son, e - le - i - son, e - le - i - son.

- i - son, e - le - i - son, e - le - i - son.

6 4 3 7 5 6 9 6 5 7 # 8 # 7 5 6 5 4 # 7 # 5 6 6 4 5 #

34

- ste e - le - i - son, e - le

- ste e - le - i - son, e - lei

7 5 4 # 6 5 6 4 7 2 7 5 4 # 4 3 # 7 5 # # 4

38

- ste e - le - i - son, e - le

- ste e - le - i - son, e - lei

6 # 2 5 9 9 6 5 9 6 5 6 5 # - 6 6 6 4 #

42

- ste e - le - i - son, e - lei

- ste e - le - i - son, e - lei

6 4 6 4 2 6 # 6 5 3 6 # 5 6 # 6 4 6 # 5 # 5 9 8 4 3 6 4 2+ 6 # 6 5

46

- i - son, Chri - ste, Chri-ste e - le - i - son, e - le -
- son, Chri - ste, Chri-ste e - le - i - son, e - le -

9 8 6 4 6 5 3
4 3 3 4 5 3

49

- i - son, e - le - i - son, - i - son, e - le - i - son. le - ri - ste e - le - i -

7 6 9 6 7 9 6 # 7 5 7 5 7 #
5 [4] 5 5 5 # 6 # 5 # 5 #

53

son.
son.

6 7 6 6 3 6 9 3
4 5 # 4 4 5 2

56

Chri -

9 6 6 9 6 5 6 6 6 4 # 6 6 7 4
5 5 5 5 5 # 6 5 4 # 5 4

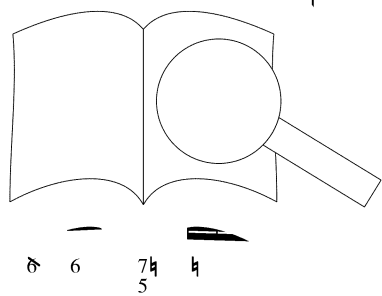

PROBEKOPPIE
Ausgabequalität gegenüber Original evtl. gemindert • Evaluation Copy - Quality may be reduced • Carus-Verlag

59

Chri-ste e - le - i - son, e - le - i - son, e - le - i - son, e - le - i - son, Chri-ste e -

7 $\frac{1}{4}$ 6 7 # 5 $\frac{1}{4}$ 5 6 7 7 6 5 7 6 6 5 3

62

son, e - le - i - son, Chri - ste e - le - i - son. i - son, Chri - ste e - le -

9 3 6 7 4 3 7 4 5 4 $\frac{1}{4}$ 3 7

65

- i - son, e - le - i - son, e - son, Chri - ste e - le - i - son, e -

6 5 7 9 6 5 7 5 5 4 3 6 # 2

68

- i - son, Chri - ste, Chri - ste i - son, Chri - ste, Chri - ste

6 7 $\frac{1}{4}$ 6 7 6 6 5 6 5 6 4 3 7 $\frac{1}{4}$ 7 $\frac{1}{4}$ 5 3 $\frac{1}{4}$

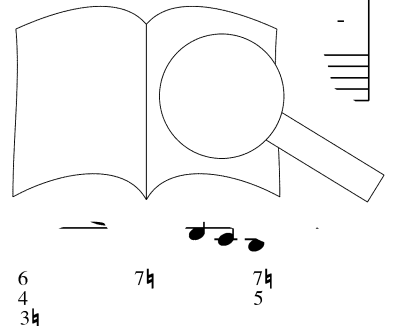

71

i - son, Chri - ste e - le - i - son, e - i - son, Chri - ste e - le

6 5 6 6 7 6 9 6 6 7 8 7 5 6

5 4 3

74

le - i - son, e - le - i - son, Chri - ste e - le

le - i - son, e - le - i - son,

5 6 8 7 6 5 6 4 5 4 3 8 7 9 7 7 3

5 3 4 3 4 2

78

4 3 5 6 6 6 7 6 7 # 6 6 6 6 7

2 4 5 6 7 5 # 4 4 2

6 6 6 6 9 3 9 9 6 6 6 5 6 6

4 4 2 5 5

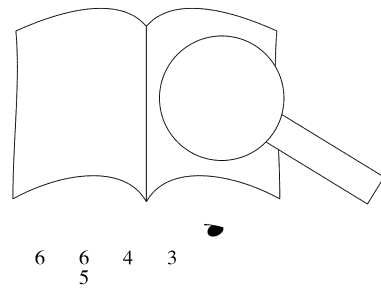

6 6 4 3
5

Kyrie II sequitur

3. Kyrie II

Alla breve

Soprano I, II
Flauto traverso I, II
Oboe d'amore I
Violino I

Alto
Oboe d'amore II
Violino II

Tenore
Viola

Basso
Fagotto I, II

Continuo

* Zu Artikulationsbögen in den Originalstimmen **B** siehe die „Hinweise zur Notation und Aufführungspraxis“. / Concerning phrasing slurs in the original set of parts **B** see the "Issues of notation and performance practice."

** Instr.: **tr**

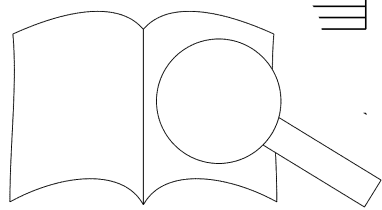

15

le - i - son, e - - - le - i - son, Ky - ri - e e - lei - son, e - lei - - - son, -
 - i - son, e - lei - - - son, Ky - ri - e e - lei - son, Ky - ri - e e - lei -
 Ky - ri - e e - lei - - - i - son, Ky - ri - e e - lei - son, e - lei - - - i -

6 7 7 6 7 6 - 5 9 8 7 6 6 5 6 6
 4 5 6 4 # 4 5 4 #
 2 2

20

Ky - ri - e e - lei - - son, e - le - i - son, Ky - ri -
 - son, e - le - i - son, e - - - le - i - - i - son, Ky - ri - e e -
 le - - - i - son, e - - - le - i - son, e - le - i -

7 5 7 5 6 6 6 6 5 5 - 9 8 7 6
 # 5 # 4 6 6 4 # 4 7 6
 2 2

25

son, e - - - son, e - le - i - son, e - le - - -
 - - - i - son, e - le -
 ri - e e - lei - son, e - le - i - son, e - - - le -
 - e - lei - - son, e - le - i - son, e - le -

6 6 5 6 7 6 6 7 6 5 6 5 7 6 7 4 3 6 6
 # 3 5 4 - 4 6 6 7 6 5 # 5 9 8 6 6
 3 2 4 4 2 4 2

* Va: *pp*
 Carus 31.232

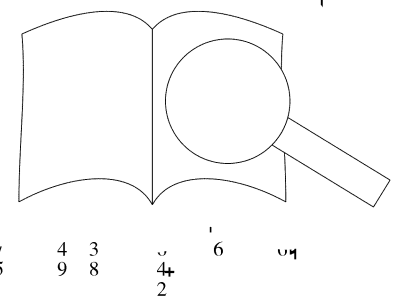

30

- i - son, e - le - - i - son. Ky - ri - e e - le - i - son, e -

*
 - i - son, Ky-ri - e e - le - i - son, Ky - ri - e e - le - - i -

8
 e e - lei - - son, e - le - i - son, Ky - ri - e e - le - i - son, Ky - r:

**
 le - - i - son, Ky - ri - e e - le - - i - son, Ky -

9 8 7 6 7 6 6 5 6 5 6 6 5 6 7 5 # 6 3 8 - 7 7 6 5 4 6 5
 # # # 4 # 4 3 4 2 5 4 # 4 6 2 4 5 4

35

le - i - son,

son, Ky - ri - e e - lei - - ri - e e - le - -

8
 le - i - son, Ky - ri - e i - son, Ky - ri - e e - le - -

le - i - son,

6 5 5 6 4 6 5 6 9 8 7 6 6 9 8
 4 # 4 5 # 4 5 5

40

lei - - son, e - le - i - son, Ky - ri - e e - le -

 on, Ky - ri - e e - lei - son, Ky - ri - e e - lei - -

- i - son, Ky - ri - e e - le - i - son, Ky - ri -

Ky - ri - e e - lei - - son, e - le - i - son

5 9 8 7 7 6 8 6 6 5 6 6 6 6 [-] 8 4 3 2 3 2 2
 5 4 3 4 2 2 3

* Instr.: / ** Fg: / *** Va: / **** Obda II:

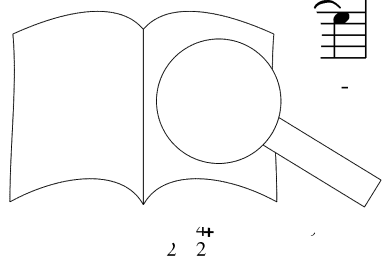

45

- - - i - son, e - le - - - i - son, e - - le - i - son, e -
 - - - son, Ky - ri - e - e - le - - - i - son, e - le - - - i - son, e -
 e - e - le - - - i - son, e - lei - son, e - le - i - son, Ky - ri - e - e - le - i - s
 lei - - - - son, e - le - i - son, e - lei - son,

5 6 9 3 6 9 7 6 8 8 6 5 4 #
 4 5 5 7 5 5 5 5 5 5 5 5

50

- - le - i - son, Ky - ri - e - e - le - i - son, - - - e - i - son,
 le - - i - son, Ky - ri - e - e - le - - - ri - e e - le - i -
 * e e - le - i - son, - - - i - son, - - - Ky - ri - e e -
 le - - - i - son, - - - e - e - le - i - son, Ky - ri -

6 6 5 6 5 6
 4 5 3 4 3 6

#

5 6 6 7 5# 9 5# 6 6 8 7
 # 4 4# 6 7 5# # 5# 6 8 7
 2 2 3 3 5 5 5

55

Ky - ri

 son, e - le - i - son, Ky - ri - e e - le - - i - son.
 - - son, e - le - i - son, Ky - ri - e e - le - - i - son.
 - - son, e - le - i - son, Ky - ri - e e - lei - - son, e - le - i - son.
 lei - - son, e - le - i - son, - - - Ky - ri - e - e - le

6 7 7 6 3 # 6 8 6 6 5# 7 6# 5 # - 9 8 5
 4 5 # - 3 # 4# 6 6 5# # 4 4 # - 9 5 5
 2 2 2 2 2 2 2 2 2 2 2 2

* Va: ** Instr.: *** Va: **** Instr.:

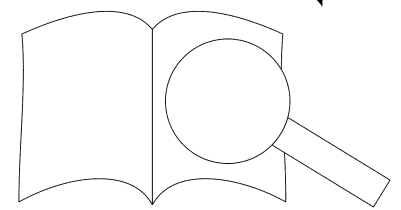

4a. Gloria in excelsis Deo

Vivace

Tromba I
in Re / D

Tromba II
in Re / D

Tromba III
in Re / D

Timpani
in Re-La / d-A

Flauto traverso I

Flauto traverso II

Oboe I

Oboe II

Fagotto I, II

Violino I

Violino II

Viola

Soprano I

Soprano

Continuo

5
2

5
4
2

6

6

6
4

9

5
3

5

6
5

#

7

6

#

6

6
5

7

6

PROBENPAPIER
Ausgabequalität gegenüber Original evtl. gemindert • Evaluation Copy - Quality may be reduced • Carus-Verlag

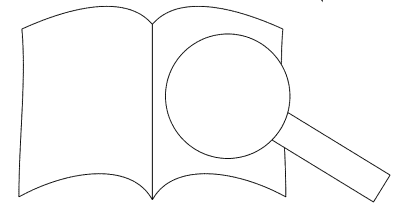

First system of musical notation, featuring vocal lines and piano accompaniment. The piano part includes a bass line and a treble line with a trill (tr) marking.

Second system of musical notation, primarily piano accompaniment in treble and bass clefs.

Third system of musical notation, primarily piano accompaniment in treble and bass clefs.

Fourth system of musical notation, primarily piano accompaniment in treble and bass clefs.

Fifth system of musical notation, primarily piano accompaniment in treble and bass clefs.

Sixth system of musical notation, including piano accompaniment and a diagram of a hand position with finger numbers 6, 5, 6, 5, 6, 4, 3, 6.

PROBENPAPIER
 Ausgabequalität gegenüber Original evtl. gemindert • Evaluation Copy - Quality may be reduced • Carus-Verlag

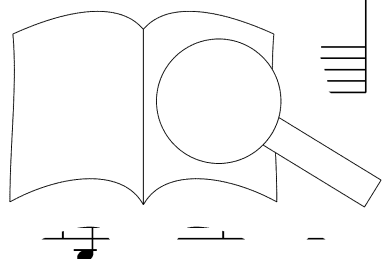

First system of musical notation, featuring vocal lines and piano accompaniment.

Second system of musical notation, featuring vocal lines and piano accompaniment.

Third system of musical notation, featuring vocal lines and piano accompaniment.

Fourth system of musical notation, featuring vocal lines and piano accompaniment.

Fifth system of musical notation, featuring vocal lines and piano accompaniment.

Sixth system of musical notation, featuring vocal lines and piano accompaniment.

Seventh system of musical notation, featuring vocal lines and piano accompaniment.

Eighth system of musical notation, featuring vocal lines and piano accompaniment.

PROBEKOPPIE
 Ausgabequalität gegenüber Original evtl. gemindert • Evaluation Copy - Quality may be reduced • Carus-Verlag

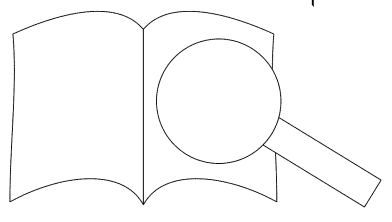

6 6 6 7 6 5 7 6 #
 4 4 4 4 4 3 6 5
 2 2 3 3

First system of musical notation, featuring vocal staves and piano accompaniment.

Second system of musical notation, primarily piano accompaniment.

Third system of musical notation, primarily piano accompaniment.

Fourth system of musical notation, primarily piano accompaniment.

Fifth system of musical notation, featuring vocal staves with lyrics: "glo - ri - a in ex -" and "glo -".

Sixth system of musical notation, primarily piano accompaniment, with a diagram of a book and a magnifying glass below it.

7 6 # 6 6 # 7 6 # #

PROBENPAPIER
 Ausgabequalität gegenüber Original evtl. gemindert • Evaluation Copy - Quality may be reduced • Carus-Verlag

First system of musical notation, featuring a vocal line and piano accompaniment.

Second system of musical notation, featuring a vocal line and piano accompaniment.

Third system of musical notation, featuring a vocal line and piano accompaniment.

Fourth system of musical notation, featuring a vocal line and piano accompaniment.

Fifth system of musical notation, featuring a vocal line and piano accompaniment.

Sixth system of musical notation, featuring a vocal line and piano accompaniment.

Seventh system of musical notation, featuring a vocal line and piano accompaniment.

Eighth system of musical notation, featuring a vocal line and piano accompaniment.

Ninth system of musical notation, featuring a vocal line and piano accompaniment.

PROBEKOPPIERT
 Ausgabqualität gegenüber Original evtl. gemindert • Evaluation Copy - Quality may be reduced • Carus-Verlag

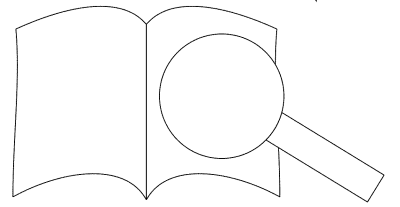

6 4 7 # 6 5 5+ 6 7 # 9 8 5 2 4 4 2 4 4 # 5 # 7 6 #

- sis, in ex - cel - sis, in ex - cel - sis De - - o, glo - - ri - a,
 - sis, glo - ri - a in ex - cel - sis
 - sis, in ex - cel - sis De - - o, glo - - ri - :

PROBEKOPPIE
 Original evtl. gemindert • Evaluation Copy - Quality may be reduced • Carus-Verlag

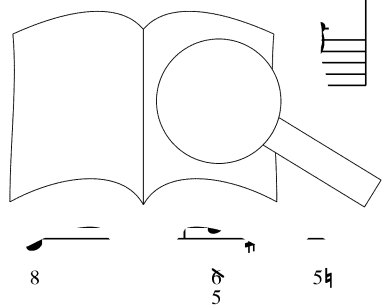

tr

glo - sis De - o,
 glc - cel - sis De - o,
 cel - sis De - o,
 Je - o, in ex - cel - sis De - o,

o, glo - ri - a in ex - cel - sis De - o,

9 8 5 6 6 6 6 5
 5 5 4 6 4 # 2

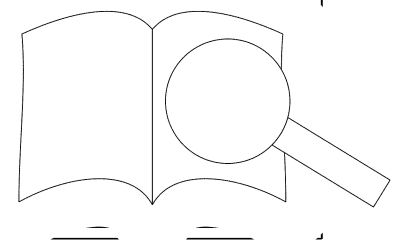

PROBEKOPPIE
 Ausgabequalität gegenüber Original evtl. gemindert • Evaluation Copy - Quality may be reduced • Carus-Verlag

musical score with vocal line and piano accompaniment

glo - - -

glo - - - ri - a in ex - cel - sis,

- - - ri - a in ex - cel - sis, ex -

glo - - -



4 2 7 6 5 7 # 6 5 6 5

glo - ri - a, glo - ri - a
 glo - ri - a, glo - ri - a
 a, glo - - - ri - a
 - ri - a, glo - ri - a, glo - ri - a

sis De - o, glo - ri - a, glo - ri - a

5 6
2

5 6
4 5
2

6 6

6
4

PROBENPAPIER
 Ausgabequalität gegenüber Original evtl. gemindert • Evaluation Copy - Quality may be reduced • Carus-Verlag

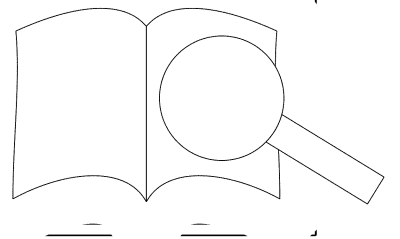

First system of musical notation, featuring vocal lines and piano accompaniment.

Second system of musical notation, primarily piano accompaniment.

Third system of musical notation, primarily piano accompaniment.

Fourth system of musical notation, including vocal lines with lyrics and piano accompaniment.

in ex - cel - sis, in ex - cel - sis,
 in ex - cel - sis, in ex - cel - sis,
 in ex - cel - sis De - o, in ex

Fifth system of musical notation, including piano accompaniment and fingerings.

5 3 5 6 5 7 # 9 7 8 6 5 # 6 6 5 6 5 7 9 7 8 6 5 3

PROBEKOPPIE
 Ausgabequalität gegenüber Original evtl. gemindert • Evaluation Copy - Quality may be reduced • Carus-Verlag

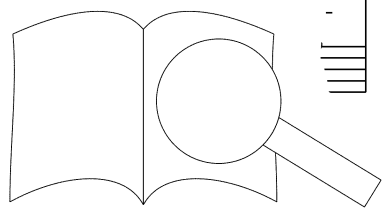

First system of musical notation, featuring a vocal line with a trill (tr) and piano accompaniment.

Second system of musical notation, primarily piano accompaniment.

Third system of musical notation, primarily piano accompaniment.

Fourth system of musical notation, primarily piano accompaniment.

Fifth system of musical notation, featuring a vocal line and piano accompaniment.

in ex - ce'

glo - - ri - a in ex - cel - sis De -

- - ri - a, glo - - ri - a in ex - cel - sis De -

glo - ri - a in ex - cel - sis De - o, in ex - cel - sis De -

ri - a in ex - cel - sis De - o, in ex - cel -

- - ri - a in ex - cel - sis De - o, glo - ri - a in e

6 5 6 5 6 5 4 6 6 5 4

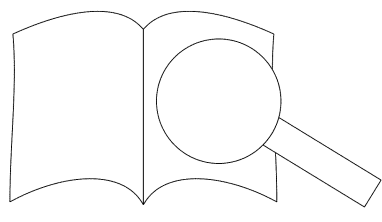

PROBENPAPIER
 Ausgabequalität gegenüber Original evtl. gemindert • Evaluation Copy - Quality may be reduced • Carus-Verlag

Empty musical staves for vocal and piano accompaniment.

Musical notation for the first system of the piano accompaniment.

Musical notation for the second system of the piano accompaniment.

Musical notation for the third system of the piano accompaniment.

Musical notation for the fourth system of the piano accompaniment.

9 8 7 6 5 6 6 7 6 #
 5 6 5 4 4 4 4 5 4 #
 # 4 4 # 4 2 2 2 4 2

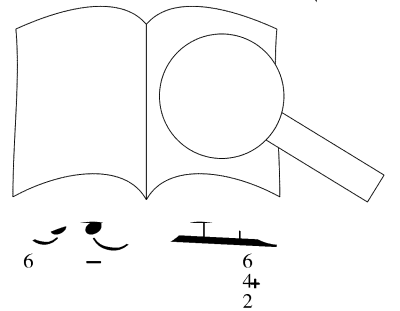

PROBENPAPIER
 Ausgabqualität gegenüber Original evtl. gemindert • Evaluation Copy - Quality may be reduced • Carus-Verlag

mi - nis,
 dax - ri - a - ca - tis,
 vo - lun - ta - tis,
 - mi - ni - bus bo - nae vo - lun - ta - tis,
 bo - nae vo - lun - ta - tis,

tasto solo

6 6 6 5+ 6 6 5
 4 4 5 2 4 4 #

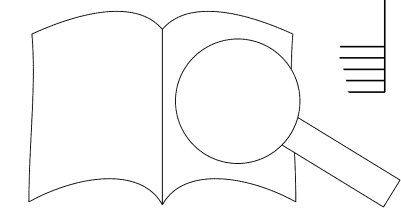

et in ter-ra pax ho-mi-ni-bus bo-nae vo-lun-

6 # 6 — 6 6 6 6 5* 6 6 6 5 7 6 6 6 7 4 —
 4 2 4 4 4 5 2 5 4 # 5 4 3

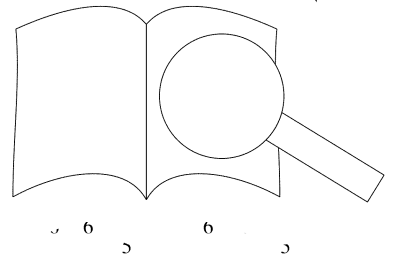

PROBENPAPIER
 Original evtl. gemindert • Evaluation Copy - Quality may be reduced • Carus-Verlag

* Siehe / See "Individual Remarks"

Empty musical staves for vocal and piano accompaniment.

First system of musical notation for the vocal line and piano accompaniment.

Second system of musical notation for the vocal line and piano accompaniment.

Third system of musical notation for the vocal line and piano accompaniment.

Fourth system of musical notation, including the vocal line with lyrics.

ta

et in ter - ra pax ho - mi - ni - bus bo - nae vo - lun - ta -

Fifth system of musical notation, including a diagram of a hand position.

6 5 6 5 6 # 5 6 6 5
 4 3 5 5 5 4 [-] #

PROBEKOPPIERT
 Ausgabequalität gegenüber Original evtl. gemindert • Evaluation Copy - Quality may be reduced • Carus-Verlag

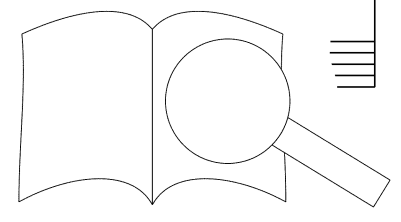

tis, ho-mi-ni-bus ho - - tis, in ter - ra pax ho-mi-ni-bus bo -

ta - - - - - tis, ho - mi-ni-

et in ter - ra pax ho - mi - ni - bus bo-nae vo-lun -

- 5 6 9 3 5 6 4 6 5 6 7 6 6 5 [-] 3

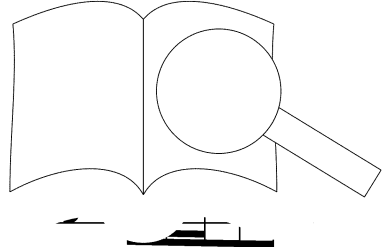

PROBEEPAARTEIL
Ausgabequalität gegenüber Original evtl. gemindert • Evaluation Copy - Quality may be reduced • Carus-Verlag

Empty musical staves for vocal and piano accompaniment.

Musical notation for piano accompaniment, first system.

Musical notation for piano accompaniment, second system.

Musical notation for piano accompaniment, third system.

- nae vo-lu - - - - - x, in ter - - ra pax, - - - - - pax ho -
et -

Musical notation for piano accompaniment, fourth system.

- lun - ta - - - - - tis, in ter - - ra pax ho - mi - ni - bus bo - nae vo - lun -
- ta - - - - -
et in - - - - - ter - ra - - - - - pax ho - mi - ni - bus bo - nae vo - lun - ta - -

Musical notation for piano accompaniment, fifth system.

5 6 9 3 6 6 5 6 # 6 6 5 [-] #

6 7 4 8 6 5

PROBENUR
Ausgabequalität gegenüber Original evtl. gemindert • Evaluation Copy - Quality may be reduced • Carus-Verlag

Three empty musical staves at the top of the page, likely for vocal or instrumental parts.

A single empty musical staff, likely for a solo instrument.

First system of the piano accompaniment, consisting of two staves (treble and bass clef) with a key signature of one sharp (F#).

Second system of the piano accompaniment, continuing the two-staff arrangement.

Third system of the piano accompaniment, continuing the two-staff arrangement.

Fourth system of the piano accompaniment, including the beginning of the lyrics: "mi - ni - n - ta - - - tis, bo - nae vo - lun-ta-tis, bo-nae".

Fifth system of the piano accompaniment, including lyrics: "pax ho - mi - ni - bus bo-nae vo - lun - ta - - - tis, bo-".

Sixth system of the piano accompaniment, including lyrics: "- tis, pax ho - mi - ni-bus bo - nae vo - lun-ta - tis, bo - nae".

Fingerings and chord diagrams for the piano accompaniment, including numbers like 5, 6, 7, 5, 6, 5, 6, 6, 6, 5, and a diagram showing a 5th fret chord with a sharp sign.

PROBEPARTITUR
Ausgabequalität gegenüber Original evtl. gemindert • Evaluation Copy - Quality may be reduced • Carus-Verlag

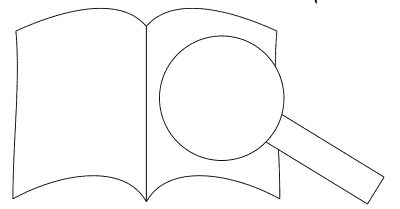

First system of musical notation, featuring vocal staves and piano accompaniment.

Second system of musical notation, featuring vocal staves and piano accompaniment.

Third system of musical notation, featuring vocal staves and piano accompaniment.

Fourth system of musical notation, featuring vocal staves and piano accompaniment.

Fifth system of musical notation, featuring vocal staves with lyrics and piano accompaniment.

vo - et in ter - ra pax, et in -
 et in ter - ra pax, et in -
 et in ter - - ra pax, et in ter -
 - tis, et in ter - - ra pax, r -
 - lun-ta - tis, et in ter - - ra pax,

Sixth system of musical notation, featuring piano accompaniment.

PROBEKOPPIERT
 Ausgabequalität gegenüber Original evtl. gemindert • Evaluation Copy - Quality may be reduced • Carus-Verlag

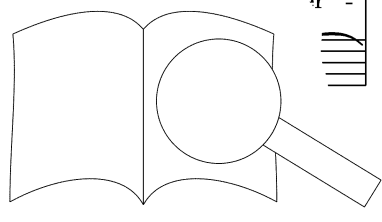

Musical notation for the first system, including vocal line and piano accompaniment.

Musical notation for the second system, including vocal line and piano accompaniment.

Musical notation for the third system, including vocal line and piano accompaniment.

Musical notation for the fourth system, including vocal line and piano accompaniment.

Musical notation for the fifth system, including vocal line and piano accompaniment.

Musical notation for the sixth system, including vocal line and piano accompaniment.

ter - ra - in - ter - ra pax ho-mi-ni - bus bo-nae vo-lun-ta -
 ter - et in ter - ra pax ho-mi-ni - bus bo-nae vo - lun-ta -
 et in ter - ra pax ho - mi-ni-bus bo-nae vo - lun-ta -
 in ter - - - ra pax ho - mi-ni -
 a pax, et in ter - - ra pax ho - mi-ni -

PROBEKOPPIE
 Ausgabqualität gegenüber Original evtl. gemindert • Evaluation Copy - Quality may be reduced • Carus-Verlag

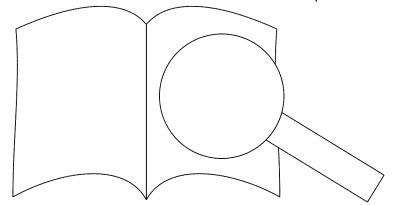

- 7 $\frac{4}{4}$ 3 7 $\frac{4}{4}$ 6 5 4 2 6 6 6 5 4 3

First system of musical notation, featuring vocal lines and piano accompaniment.

Second system of musical notation, featuring vocal lines and piano accompaniment.

Third system of musical notation, featuring vocal lines and piano accompaniment.

Fourth system of musical notation, featuring vocal lines and piano accompaniment.

Fifth system of musical notation, featuring vocal lines and piano accompaniment.

Sixth system of musical notation, featuring vocal lines and piano accompaniment.

tis, bo
 tis,
 tis, et in ter - ra pax ho - mi - ni - bus bo-nae vo - lun -
 -nae vo - lun - ta - tis,
 tis, bo-nae vo - lun - ta - tis,

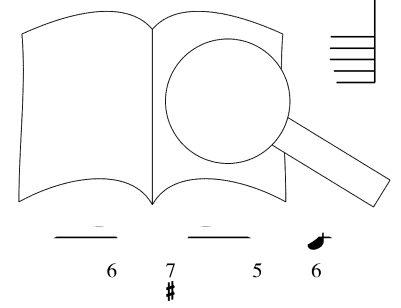

PROBE PAPIER
 Ausgabequalität gegenüber Original evtl. gemindert • Evaluation Copy - Quality may be reduced • Carus-Verlag

- - tiae vo-lun-ta-tis, in-ter-ra pax ho-

vo-lun-ta- et in-ter-ra pax ho-mi-ni-bus

6 4 5 [-]# - 5 6 5 6 6h 5 4 6 5h 3 5 6 7 3 6 6 5 [-] 3

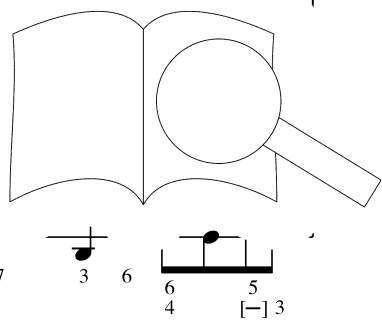

PROBEKOPPIE
 Original evtl. gemindert • Evaluation Copy - Quality may be reduced • Carus-Verlag

mi - ni-bus ho - - - - - as, pax, pax, pax, pax, in ter - - - - - ra

so - - - - - nae vo - lun - ta - - - - - tis, in ter - - - - - ra

nae vo - lun - ta - - - - - et in - - - - - ter - - - - - ra - - - - - pax ho -

PROBE
 Ausgabqualität gegenüber Original evtl. gemindert • Evaluation Copy - Quality may be reduced • Carus-Verlag

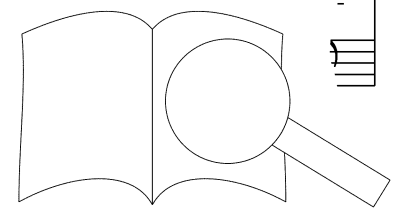

First system of musical notation, featuring vocal staves and piano accompaniment.

Second system of musical notation, featuring vocal staves and piano accompaniment.

Third system of musical notation, featuring vocal staves and piano accompaniment.

Fourth system of musical notation, featuring vocal staves with lyrics and piano accompaniment.

Fifth system of musical notation, featuring vocal staves with lyrics and piano accompaniment.

PROBEKOPPIERUNG
 Ausgabequalität gegenüber Original evtl. gemindert • Evaluation Copy - Quality may be reduced • Carus-Verlag

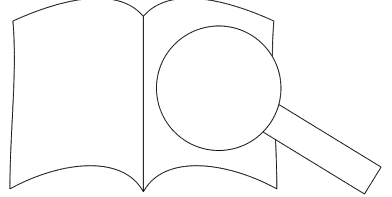

6 5 6 7 \sharp 6 7 \sharp 6 6 6 6 6 5 6 5
 4 4 [-] 3 4 5 4 4 4 4 5 4 3

First system of musical notation, featuring a vocal line and piano accompaniment.

Second system of musical notation, featuring a vocal line and piano accompaniment.

Third system of musical notation, featuring a vocal line and piano accompaniment.

Fourth system of musical notation, featuring a vocal line with lyrics and piano accompaniment.

tis, bo - nae vo - lun - ta-tis, pax

tis bo - nae vo - lun - ta-tis, pax

bo - nae vo-lun - ta - tis, pax,

bo - nae vo-lun - ta

bo - nae vo - lun-ta

Fifth system of musical notation, featuring piano accompaniment and a diagram of a book.

6 7 7 #

6 7 4# 5 6 7 #

6 7 7 #

PROBENPAPIER
 Ausgabequalität gegenüber Original evtl. gemindert • Evaluation Copy - Quality may be reduced • Carus-Verlag

tr

ho - mi - ni - ta - tis, et in - ter - ra - pax, et in - ter - ra - pax, et

h nae vo - lun - ta - tis, in ter - ra pax, in ter - ra pax,

si vo - nae vo - lun - ta - tis, et in ter - ra pax, et

pax, et in ter - ra pax, et in

PROBEKOPPIE
 Ausgabequalität gegenüber Original evtl. gemindert • Evaluation Copy - Quality may be reduced • Carus-Verlag

First system of musical notation, featuring three vocal staves and piano accompaniment.

Second system of musical notation, featuring three vocal staves and piano accompaniment.

Third system of musical notation, featuring three vocal staves and piano accompaniment.

Fourth system of musical notation, featuring three vocal staves and piano accompaniment.

Fifth system of musical notation, featuring three vocal staves and piano accompaniment.

Sixth system of musical notation, featuring three vocal staves and piano accompaniment.

in te. ho - mi - ni - bus bo - nae vo - lun - ta -
 et te. ho - mi - ni - bus bo - nae vo - lun - ta -
 pax, et in - ter - ra pax ho - mi - ni - bus bo - nae vo - lun - ta -
 - ra pax, et in - ter - ra pax ho - mi -
 in ter - ra pax, in - ter - ra pax ho - mi - ni - bus bo

7 6 6 7 6 7 6 7 # 6 6 6 5
 # 4 5 6 4 5 # 6 6 4 #
 2

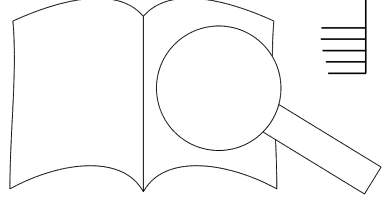



The image displays a musical score for an organ with vocal lines. It consists of several systems of staves. The top system includes three treble staves and one bass staff. The middle system includes two treble staves and one bass staff. The bottom system includes two treble staves and one bass staff. The lyrics are written below the vocal lines. The score includes various musical notations such as notes, rests, and ornaments. A large watermark 'PROBEPARTITUR' is overlaid diagonally across the page, along with the text 'Ausgabequalität gegenüber Original evtl. gemindert' and 'Evaluation Copy - Quality may be reduced'. The Carus-Verlag logo is also present in the top right corner.

Original evtl. gemindert • Evaluation Copy - Quality may be reduced • Carus-Verlag

tis, ho - mi - ni - ta - - tis, bo - nae vo - - lun - ta - tis.
- tis, - in - ter - ra - pax ho - mi - ni - bus bo - nae vo - lun - ta - tis.
lun - ta - - - - - tis.
ter - ra pax, pax, pax ho - mi - ni - bus bo - nae
in ter - ra - pax, in ter - ra pax ho - mi - ni - bus bo - nae

5. Laudamus te

Violino solo

Violino I

Violino II

Viola

Soprano II

Continuo

6 6 6 6 6 6 6 4 2

4

6 6 7 # 6 6 5 7 6

6

6 4 2 6 6 4 5 # 8 7 4 6 6 6 6 # 5 6 6

8

7 6 5 6 6 7 4 7 6

10

6 6 5 4 7 # 6 5

12

Sop.

Lau - da -

6 7 5

p 7 4 6 4

15

- - - mus te, lau - da - mus te,

5 4 6 6 6 6 6 7

18

da - - - mus he - ci-mus te, ad - o - ra - - tasto solo

6 7

21

- - - mus te, glo - ri - -

6 6 # 6 7 6 7 7 #

PROBEKOPPIE
 Ausgabequalität gegenüber Original evtl. gemindert • Evaluation Copy - Quality may be reduced • Carus-Verlag

24

da-mus te, be-ne - di - ci - mus te, ad - o - ra - - -

7 7 7 # 5 6 5 6 5 6 6 5

26

ri - fi - ca - mus te.

6 4 2 6 4 5 # 6 6 5 6 6 # 5 6 4

29

7 4 5 7 # # 6 5 6 7 #

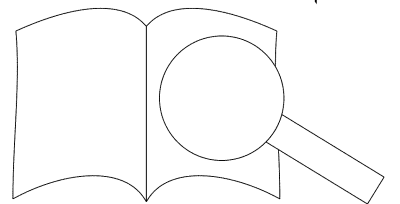

31

da - mus te, be - ne - di - ci - mus te, ad - o - ra - mus te, glo - ri - fi - ca - mus te, glo - ri - fi - ca - mus te.

34

glo - ri - fi - ca - mus te, glo - ri - fi - ca - mus te.

37

glo - ri - fi - ca - mus te, glo - ri - fi - ca - mus te.

39

Ad - o - ra -

7 # 6 6 5 7 6 6 6 6 5 #

2 4 4

42

ca - - - - mus te, glo - ri - i. *mf* glo - ri - fi - ca - - - -

7 7 6 4 5 5 2 5 5 6 7

5 # 5 2 2 4 2

45

- - - - - mus te, lau - da -

pp *pp* *pp* *tr* *tr*

7 7 7 7 6 6 6 5 #

5 5 4 4 6 4 5 #

2 3 4 4

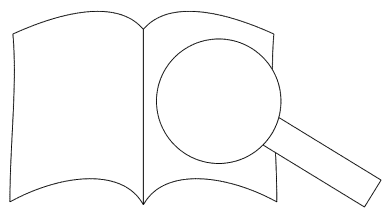

48

- mus te, lau - da

7h 6h 6 5h 6 6 6

51

lar - da - te, lau - da - - mus te, be - ne -

7 6 7 4 # 6 7 # 6

54

ci - mus te, ad - o - ra - mus te, glo - ri - - fi -

6 6 7 7 6 7 7 7 7

PROBENPAPIER
 Ausgabequalität gegenüber Original evtl. gemindert • Evaluation Copy - Quality may be reduced • Carus-Verlag

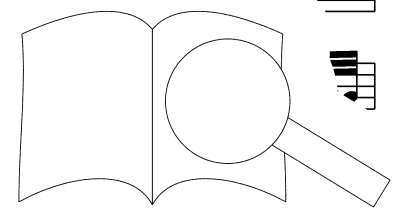

56

da-mus te, be-ne-di-ci-mus te, ad-o-ra-

6 7 7 7 6 5 6 5 6 5 6 6 5

58

ri-fi-ca-mus

6 4 2 6 6 4 7 6 6 5

60

6 6 6 6 4 7 4 6 5 6 7 5

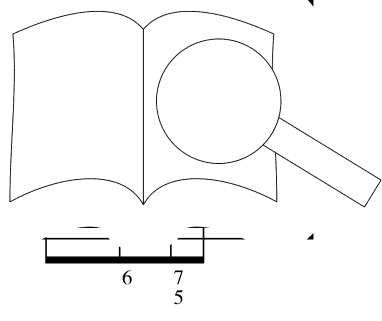

PROBE PAPIER
 Ausgabequalität gegenüber Original evtl. gemindert • Evaluation Copy - Quality may be reduced • Carus-Verlag

6. Gratias agimus tibi

Alla breve

Tromba I
in Re / D

Tromba II
in Re / D

Tromba III
in Re / D

Timpani
in Re-La / d-A

Flauto traverso I, II
Oboe I

Oboe II

Fagotto I, II

Violino I

Violino II

Viola

Soprano I, II

Alto

SSO

Continuo

The musical score is arranged in systems. The top three systems are for the Tromba I, II, and III parts, all in D major. The fourth system is for the Timpani part. The fifth system contains the Flauto traverso I, II and Oboe I parts. The sixth system contains the Oboe II part. The seventh system contains the Fagotto I, II part. The eighth system contains the Violino I, Violino II, and Viola parts. The ninth system contains the Soprano I, II part with the lyrics "Gra - ti-as a - gi-mus ti -". The tenth system contains the Alto part with the lyrics "Gra - ti-as a - gi-mus ti - bi". The eleventh system contains the Continuo part with the lyrics "Gra - ti-as a - gi-mus ti - bi". The bottom system contains the Continuo part with the lyrics "Gra - ti-as a - gi-mus ti - bi".

PROBEPARTITUR

Ausgabequalität gegenüber Original evtl. gemindert • Evaluation Copy - Quality may be reduced • Carus-Verlag

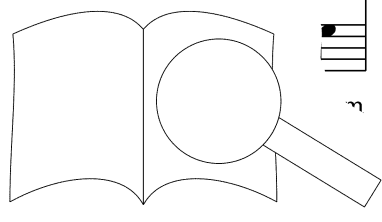

bi pro - pter ma-gnam glo - - - - -

- - - - - pter ma-gnam glo - - - - - ri-am tu -

- - - - - ri-am tu - am,

- - - - - ri-am tu - am,

4 6 6 6 5 7 4 3 5 6 7 6 5

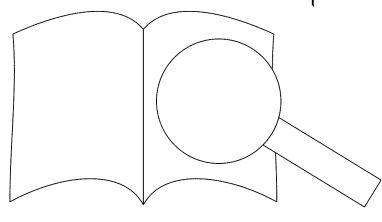

PROBEKOPPIE
 Ausgabqualität gegenüber Original evtl. gemindert • Evaluation Copy - Quality may be reduced • Carus-Verlag

PROBEPARTITUR
Ausgabequalität gegenüber Original evtl. gemindert • Evaluation Copy - Quality may be reduced • Carus-Verlag

- ri gra - - - ti - as a - - - -

gra - - - ti - as a - - - - gi - mus

- - - ti - as a - - - - gi - mus ti - bi

- - - ti - as a - - - - gi - mus ti - bi

7 6 6 5 6 4 6 6 7 6 6 6 6 4 5 3 6 6

2 2 5 4 4 4 3 4 4 5 5

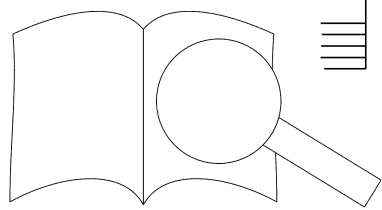

PROBE
Ausgabequalität gegenüber Original evtl. gemindert • Evaluation Copy - Quality may be reduced • Carus-Verlag

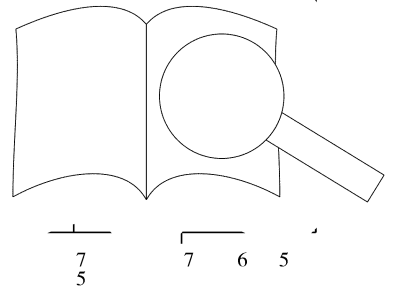

First system of musical notation, featuring a vocal line on a treble clef staff and piano accompaniment on two staves (treble and bass clefs).

Second system of musical notation, continuing the vocal line and piano accompaniment.

Third system of musical notation, continuing the vocal line and piano accompaniment.

Fourth system of musical notation, including lyrics for the vocal line and piano accompaniment.

Lyrics: a - bi pro - pter ma - gnam glo -
 - - - ti - as a - - - gi - mus ti - - bi pro -
 - - - gi - mus ti - - bi, a - - gi - mus ti - bi
 - - - am, gra - - - ti - as a - gi - mus ti

Fifth system of musical notation, including piano accompaniment and a diagram of a hand position on a keyboard.

Hand position diagram: A diagram showing a right hand with fingers numbered 1-5, positioned over a keyboard. The diagram includes a treble clef staff with notes and a corresponding keyboard layout.

PROBEPARTITUR
 Ausgabequalität gegenüber Original evtl. gemindert • Evaluation Copy - Quality may be reduced • Carus-Verlag

pro - pter ma-gnam glo - ri-am tu - am, pro -
 - ri-am tu - am, pro - pter ma-gnam
 pro - pter ma-gnam glo - ri-am tu -

pro - pter m

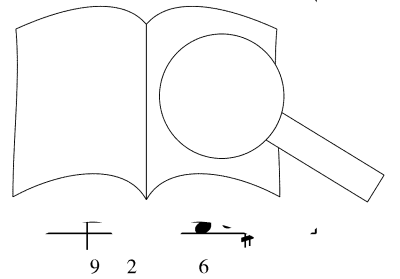

4/2 6/5 3 5 5 6/4 6/5 9 6 6/4 6/5 9 2 6

PROBENPAPIER
 Original evtl. gemindert • Evaluation Copy - Quality may be reduced • Carus-Verlag

- p'

ri-am tu - am, gra - ti - as

gra - ti - as a - gi-mus ti -

am glo-ri-am tu - am, gra - ti - as a - gi-mus

- ri-am tu - am, pro - pter ma-gnam glo-ri-am tu - a

5 4 6 5+ 6 4 7 7 6 5

2 2 2 5 2 2 5

5	6	6	6
2	5	4	5
		2	

PROBEPARTITUR
Ausgabequalität gegenüber Original evtl. gemindert • Evaluation Copy - Quality may be reduced • Carus-Verlag

a - pter ma-gnam glo-ri-am tu - am, gra - - - ti - as
 „nam glo - ri-am tu - am, gra - - - ti - as a - -
 gra - - - - ti - as a - - gi-mus ti-bi pro-pter

gra - - - - ti - as a - - - gi-mu

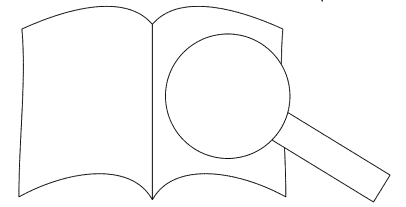

6 6 4 3 6 6 7 6 5 3 6 6 7 6 5 6 6
 4 2 4 2 9 4 4 2

PROBENPARTITUR
 Ausgabqualität gegenüber Original evtl. gemindert • Evaluation Copy - Quality may be reduced • Carus-Verlag

a - - - bi, gra - - - -
 - - bi, gra - - - ti - as a - - -
 glo - - - ri - am tu - am, gra - - - ti - as a - -
 er ma - gnam glo - ri - am tu - am,

6 6 6 6 5 6 4 7 5 6 6 6 7 6
 4 5 5 5 5 4 5 5 6 6 6 5
 2

7 7 6
 5 3 4
 2

PROBEPARTITUR
 Ausgabequalität gegenüber Original evtl. gemindert • Evaluation Copy - Quality may be reduced • Carus-Verlag

Musical notation for the first system, measures 36-38. It consists of three staves: two treble clefs and one bass clef. The key signature has one sharp (F#).

Musical notation for the second system, measures 39-41. It consists of three staves: two treble clefs and one bass clef. The key signature has two sharps (F#, C#).

Musical notation for the third system, measures 42-44. It consists of three staves: two treble clefs and one bass clef. The key signature has two sharps (F#, C#).

Musical notation for the fourth system, measures 45-47. It consists of three staves: two treble clefs and one bass clef. The key signature has two sharps (F#, C#).

Musical notation for the fifth system, measures 48-50. It consists of three staves: two treble clefs and one bass clef. The key signature has two sharps (F#, C#).

gi - mus ti - - bi pro - - pter ma - gnam
 gi - mus ti - - bi pro - - pter ma - gnam glo - -
 - gi - mus ti - bi, - a - gi - mus ti - bi pro - - pter
 - ti - as a - - - gi - mus ti -

6 6 9 8 7 6 5 6 6 7 8 4 3
 5 5 2 5 3 4 2

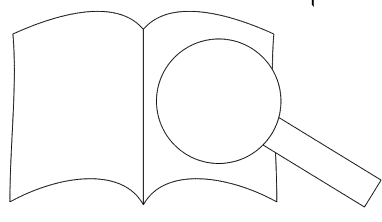

PROBEPAPIER
 Ausgabequalität gegenüber Original evtl. gemindert • Evaluation Copy - Quality may be reduced • Carus-Verlag

Three staves of piano introduction. The top two staves are in treble clef, and the bottom staff is in bass clef. The music consists of simple chords and melodic lines.

Three staves of piano accompaniment. The top two staves are in treble clef, and the bottom staff is in bass clef. The music features a rhythmic pattern of eighth and sixteenth notes.

Three staves of piano accompaniment. The top two staves are in treble clef, and the bottom staff is in bass clef. The music continues with the rhythmic pattern from the previous system.

Vocal line with lyrics. The music is in treble clef with a key signature of one sharp (F#). The lyrics are:

glo - ri - am tu - am, pro - pter ma - gnam glo - ri - am tu - am, gra -

- ri - am tu - am, pro - pter ma - gnam glo - ri - am tu - am,

ma - gnam glo - ri - am tu - am,

Fingerings for the piano accompaniment: 6, 4, 2, 6, 5, 9, 6, 6, 5, 4, 3, 6, 7, 4.

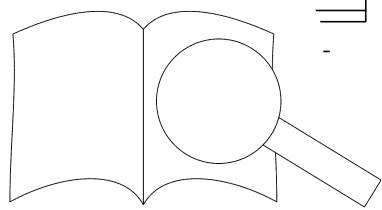

PROBE
 Ausgabqualität gegenüber Original evtl. gemindert • Evaluation Copy - Quality may be reduced • Carus-Verlag

tu - na - gnam glo - - ri-am tu - am.
 - mus ti - bi pro - pter ma - gnam glo - - ri-am tu - - am.
 - ti - as a - gi-mus ti-bi pro-pter ma - gnam glo - ri-am tu - - am.
 tu - - - - am, pro - pter ma-gnam glo -

PROBEPARTITUR
 Ausgabqualität gegenüber Original evtl. gemindert • Evaluation Copy - Quality may be reduced • Carus-Verlag

7a. Domine Deus

Duetto
Solo *

Flauto traverso

Violino I con sordino

Violino II con sordino

Viola con sordino

Soprano I

Tenore

Continuo pizz.

* Zur Notierung des lombardischen Rhythmus in T. 1 und 27 siehe die „Hinweise zur Notation und Aufführungspraxis“. / Concerning the notation of the Lombardic rhythm in mm. 1 and 27, see the "Issues of notation and performance practice."

12

4 6 # 6 4 6 # 7 6 7 5 4

16

Soprano I

Tenore

Do - mi - ne I ex coe - le

6 6 5 6 6 6 6 6 6 6 6

4 4 # 2

20

ni - te, Je - su Chri - ste al - tis - si - me,

stis, De - us Pa - ter o - mni - pot - ens,

7 6 6 5 5 6 6 6 6 6 6 6 6 5 5 7

5 4 3 4 5 6 5 4 3 3 7

24

Do - mi-ne De - - - us, Rex coe - le - - -
Do - mi-ne Fi - li u - ni-ge - -

28

- - - stis, De - - - pot-ens, Do-mi-ne De - - - us, -
- - - ni - te, al - tis - si - me, -

32

coe - le - - - stis
Do-mi-ne Fi - - li u - ni-ge - - ni-t

PROBEKOPPIE • Evaluation Copy - Quality may be reduced • Carus-Verlag

Ausgabequalität gegenüber Original evtl. gemindert

36

Do-mi-ne Fi - li - u - ni - ge - - - ni - te, Je - su
 Rex coe - le - - - - - stis,

6 6 6 6 6 6 6 6 6 5 6 6 6 5 4 2

40

tis - si - me, Do - - - - - li, Do - - - - -
 mni - pot - ens, De - - - - - us Pa - ter, Do - - - - -

6 9 8 6 5 5 7 6 4 3 9 8 6 4 6 6 9 3 9 3

44

...e Fi - li u - ni - ge - ni - te, Je - su Chri - ste al - tis - si - me, Je - su Chri
 - mi - ne De - us, Rex coe - le - stis, De - us Pa - ter o - mni - pot - ens, De - us Pa

9 6 6 5 6 5 6 6 6 5 6 5 6 5 3

PROBEKOPPIE
 Ausgabequalität gegenüber Original evtl. gemindert • Evaluation Copy - Quality may be reduced • Carus-Verlag

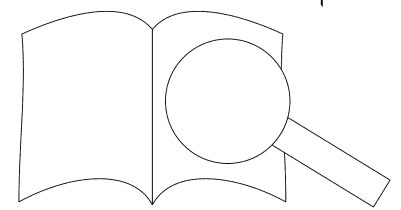

al-tis-si-me. _ Do-mi-ne De - - us, Rex coe-le - stis, Do
 o-mni-pot-ens. _ Do-mi-ne Fi-li - u - ni - ge-ni-te, Do

6 5 7

Fi-li u - ni - ge-ni-te, s, ste al-tis-si-me, Do - mi - ne
 le-stis, De - us Pa - mni - pot - ens, _

6 5 3 6 4 6 7

u - ni - ge-ni-te, Je - su Chri
 Do - mi - ne De - us, Rex coe - le - stis, De - us Pa -

6 6 6 6 7 4 3 6 7 6 4 3 7 6 5 6

PROBENUR
 Ausgabqualität gegenüber Original evtl. gemindert • Evaluation Copy - Quality may be reduced • Carus-Verlag

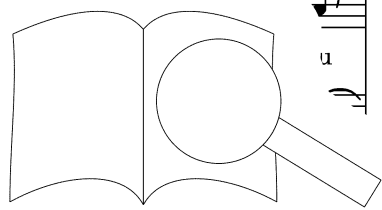

Musical score for measures 59-62. It includes a vocal line with lyrics and a piano accompaniment. The lyrics are: "Chri-ste al - tis - si - me. - us Pa-ter o - mni - pot - ens." The piano part features a strong *f* dynamic and includes a trill (*tr*) in the vocal line. Fingering numbers are provided for the piano part.

Musical score for measures 63-66. This section continues the piano accompaniment with various rhythmic patterns and dynamics. Fingering numbers are provided for the piano part.

Musical score for measures 67-70. This section continues the piano accompaniment. Fingering numbers are provided for the piano part.

PROBEKOPPIE • Original evtl. gemindert • Evaluation Copy - Quality may be reduced • Carus-Verlag

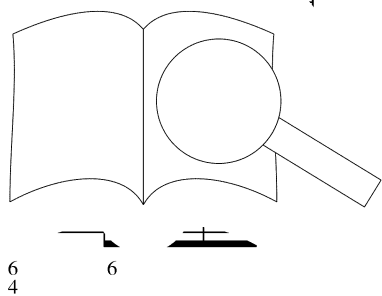

71

6 6 6 7 7 6 7 4 3 6 7
4 4 4 5 5 5 5 5 5 5 5 5
2

75

p

Do - mi-ne De - us, A - gnus De - i, - - - us, A-gnus De - i,

Do - mi-ne De - us, A - gnus De - i,

7 8 6 5 6 6 6 6 6 6 6 6
2 3 4 4 5 4 4 5 4 5 4 4

79

gnus De - i, Fi - li-us Pa - tris,

A - gnus De - i, Fi - li-us Pa - tris,

7 6 6 6 6 7 6 7 7 6 6 6
5 4 4 5 5 5 # 6 7 # 7 4 4

Do - mi-ne De - us, A - gr
Do - mi-ne De - us, A

7 8 6 7 6 7 6 6 5 6 5 3 5
4 3 3 4 3 # 4 # 4 3 5

Do - mi-ne De - us, A - gnus De - i, Fi-li-us Pa - tris,
Do - mi-ne De - us, A - gnus De - i, Fi-li-us Pa - tris,

6 7 6 6 [6] 7 6 7 6 5 6 7 # 6 6
5 4 5 5 6 5 2

...e De-us, A-gnus De-i, A-gnus De-i, Do-mi-ne De-us, A - gnus De -
Do-mi-ne De-us, A-gnus De-i, A-gnus De-i, Do-mi-ne De-us, A - gnus

6 # 6 7 3 6 7 7 5 # 5

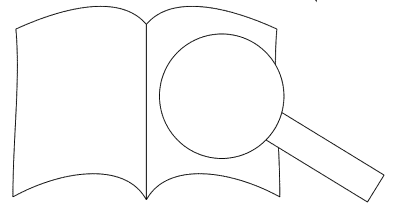

PROBEN
Ausgabequalität gegenüber Original evtl. gemindert • Evaluation Copy - Quality may be reduced • Carus-Verlag

7b. Qui tollis

Lente *

95

Flauto traverso I

Flauto traverso II

Violino I

Violino II

Viola

Soprano I

Soprano II

Alto

Tenore

Basso

Violoncello

Continuo

senza sordino

Pa - tris.

Qui tol - lis pec - ca - di,

tris. Qui tol - lis ta

coll' arco e sta

coll'

6 4 #4 7 6 5 9# 8 [4]

100

Sop

Qui tol - lis pec - ca - ta

no - bis, mi - se - re - re

di, mi - se - re - re no - bis, mi - se

Qui tol - lis pec

sim.

7# 5 9# 8 5 5 7 6 5

mun - - - di, mi - se - re - re no - bis,
 - - - re no - - - bis, mi - se
 - - - re no - -
 - - - ta mun - - - di, no

9 7 8 6 7 5 7 5 5 5 8 8

- - - ta mun - di, mi - se - re - re
 tol - lis pec - ca - - - ta mun - di,
 qui - tol - lis pec - ca -
 qui tol - lis pec

7 6 7 9 5 7 5

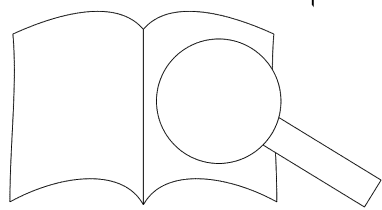

PROBEN
 Ausgabequalität gegenüber Original evtl. gemindert • Evaluation Copy - Quality may be reduced • Carus-Verlag

no - bis, mi - se - re - - - -
mi - se - re - - - -
mun - - - di, mi - se - re - - - no -
- - - - ta mun - - - di, re no -



re - re, mi - se - re - - - re -
s, mi - se - re - re no - - - bis, mi - se - re -
se - re - - - re no - - - bis,
mi - se - re - - - re, mi - se - re -



PROBEKOPPIERUNG
Ausgabequalität gegenüber Original evtl. gemindert • Evaluation Copy - Quality may be reduced • Carus-Verlag

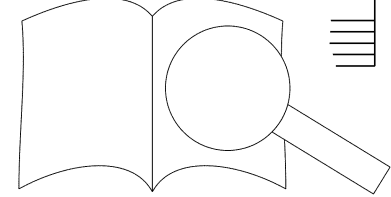

no - bis.
 re no - bis.
 re no - bis. Qui tol - lis
 bis. Qui tol - lis pec - ca
 lis - ta

ta mun - di, sus -
 ta mun - di, sus - ci -
 mun - di, sus - ci - pe
 di, sus - ci - pe

PROBEKOPPIE
 Ausgabequalität gegenüber Original evtl. gemindert • Evaluation Copy - Quality may be reduced • Carus-Verlag

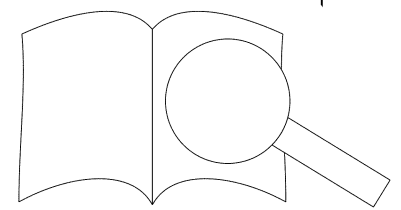

ci-pe de-pre-ca-ti-o-nem, de-pre-ca-ti-pe de-pre-ca-ti-o-nem no-strar o-nem, sus-ci o-nem, sus-ci o-nem, o-nem

de-pre-ca-ti-o-nem no-stram, sus-ciem, de-pre-ca-ti-o-nem no-stram, sus-cinem, de-pre-ca-ti-o-nem de-pre-ca-ti-o-nem

PROBEPAPIER
Ausgabequalität gegenüber Original evtl. gemindert • Evaluation Copy - Quality may be reduced • Carus-Verlag

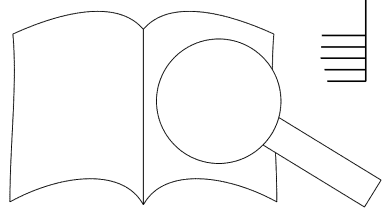

pe de - pre - ca - ti - o - - - - - nem no -
 pe de - pre - ca - - - - ti - o - - - - nem
 sus - ci - pe de - pre - ca - - - - ti -
 sus - - ci - pe de - pre - ca - - - - - nc - - - - - stram,

ca - - - ti - o - - - - nem no - - - - stram.
 re - - ca - - - ti - o - - - - nem no - - - - stram.
 - pre - - ca - - - ti - o - - - - nem no -
 de - pre - - ca - - - ti - o - - - - nem no

PROBENPAPIER
 Ausgabqualität gegenüber Original evtl. gemindert • Evaluation Copy - Quality may be reduced • Carus-Verlag

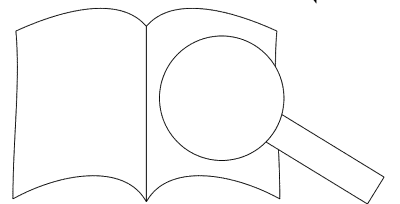

8. Qui sedes

Oboe d'amore *Solo*

Violino I

Violino II

Viola

Alto

Continuo

6 5 6 7 6 5 7

5

7 5 # 6 7 6 6 6 # 7 5

10

6 5 7 6 6 5 7 6 6 6 6 5 4 6 6 6 6 7

15

Qui —

6 7 6 6 7 6 6 6 5 6 6 5 6 6 5

4 5 # 2 4 #

20

des a tr? se

5 6 6 6 8 6 5 6 7

2 5 # 5 4 5 #

25

ad dex-tram Pa-tris, ad dex - - - tram Pa - - - ti

6 6 6 6 6 7 6 6 6

4 3 4 5 # 4 2 4 6 4 5

PROBENPAKUNGSZWECK
 Ausgabequalität gegenüber Original evtl. gemindert • Evaluation Copy - Quality may be reduced • Carus-Verlag

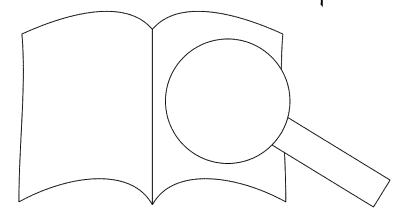

30

no - bis.

7 5 6 5 6 7 6 5

35

7 2 7 5 6 4 # 6 4 2 6 # 6 7 6 5

40

6 6 5 7 6 6 5 6 6 6 6 5 # 6 # 6 9 6

45

des ad dex-tram Pa-tris, mi-se-re

7 6 9 6 7 6 6 6 5 4 5 6 # 6

50

no-bis, qui se des ad dex-tram, ad

6 6 6 6 5 6 6 6 7 5 6 5 6 7 2 4 5 2

55

tram De-i Pa-tris,

6 6 6 6 6 7 6 7 6 5 4

PROBEKOPPIERUNG
 Ausgabqualität gegenüber Original evtl. gemindert • Evaluation Copy - Quality may be reduced • Carus-Verlag

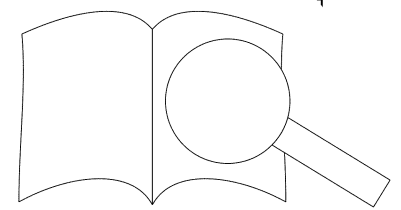

60

65

70

75

se -

6 5 6 # 5 6 5 6 6 5 5

79

- des ad dex - tram Pa tr. se - re - re no - bis.

6 5 6 4 6 4 2 6 5 6 6 6 4 # 2

83

6 6 4 2 6 6 5 6 7 # 6 5 6 6 6 5 6 4 5 #

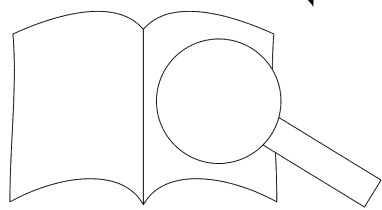

9a. Quoniam tu solus sanctus

Corno da caccia in Re / D basso

Fagotto I

Fagotto II

Basso

Continuo

11

Quo - ni - am tu

16

san - ctus, tu so - lus san-ctus, tu so - lus Do - mi-nus, - lus Do - mi - tu sr

6/5 6 7 6 6 6/5 7 7

22

- ctus, tu so - lus Do - ctus, tu so-lus Do - - mi-nus, tu so -

5b 6b 7b 6 7 5 6 6 6/5 6 6/5

27

- lus Do-mi - nus, tu so - lus san-ctus, tu so - lus

6/4 5/3 6 6 6/5 6 6/5 6/5 - 7 9/5 7 7 6/5 # 2 # 6

* Ossia-System = Version der autographen Partitur A / ossia staff = version of the autograph score A

33

qu - ni - am tu so - lus san - ctus, tu so - lus san - ctus,

6 5 7 6 6 5
4 3 4 5 4 #

38

- ctus, tu so - lus Do - ctus, tu so - lus Do - ctus, tu so - lus, so - lus

6# 6 7 7 5 6 7 6 6 6
2 4 2 # 2

43

an - - - ctus, tu so - lus Do - mi - nus,

7 5 6 8 7 5 6 6 4 # 6 5 4 6 5 4

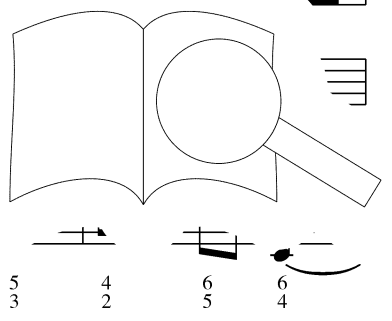

48

7 6 6 6 6 6 5
4 4 5 4

7 6
5

7 6
5

6
5

53

p

p

tis - si - mus,

tu so - lus Al - tis - si - mus, Chri - ste, tu, tu so - lus Al -

6 6
4 2

6
4

6 6 9# 8
5

6 6
5

6 7
5

58

aus, tu so - lus Al - tis - si - mus, Je - su Chri - ste,

7 6 7 7 7 6 6 6
4 4 5 4

7 6 6 5 7# 5 6 5
4 4 3 2 4 3

6 6 5 7# 5 6 5
4 3 4 3

4 6
2 5

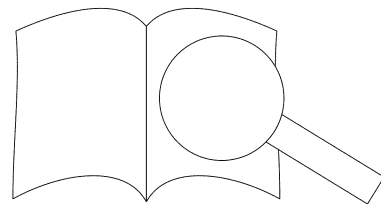

64

- - su Chri - ste, Je - - su Chri - ste,

6 6 7 6 6 4 6 7 6 6 6 5 6 5

3 # 5 5 # 4 4 # 5

70

6 6 7 7 6 6 5 4 3 6 6 # 6 4 #

2 2 5 5 5 # 6 5

75

so-lus Al - tis-si - mus, Je - - su Chri - ste,

6 6 7 6 5 6 6 9 8 # 6 6 5 6

4 2 4 6 7 6 5 6 6 # 5 5 6

80

tis-si-mus, tu so-lus Al-tis-si-mus, Je-su

6 7 6 9 8 7 5 6 7 5
4 2 5 # 5 # 7

85

Je-su
Je-su Chri-ste; quo-ni

7 5 6 6 6 5 6 4 # 6 4 3 7 5

91

tu so-lus san-ctus, tu so-lus

6 9 4 3 6 6 6 7 6 6 5 7 7
4 2 7 5 5 5

PROBEKOPPIERUNG
 Ausgabequalität gegenüber Original evtl. gemindert • Evaluation Copy - Quality may be reduced • Carus-Verlag

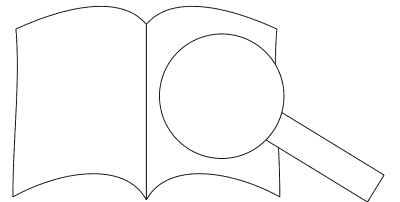

97

tu so - lus san - ctus,
 nus, tu so-lus san - ctus, tu so-lus Do

6 5 7 # 8 7 4 6 5 3

102

mi - nus,
 mi-nus, - lus Al - tis - si - mus,

6 6 7 7 6 5 6 6 6 6 5 5 6 6 7 7 #

107

Je - su Chri - ste, so-lus Do -

7 7 4 7 8 3 3 7 5 6 5 5 6 5 6 4 2 6 5 7 4

112

lus Al - tis - si - mus, Je - su Chri -
 - - - mi - nus, tu so - lus Al - tis - si - mus, Je - su

7 6 6 6 7 6 6 6 6 6 6 6 4 3
 5 4 2 5 3

117

6 5 4
 4 3 2

6 7 7 6 7 7 6

123

4 6 7 6 5 7 7 4 5 6 7 5 6
 2 5 2 5 5 5

6 6 5
 5 4 3

PROBENPAPIER
 Ausgabequalität gegenüber Original evtl. gemindert • Evaluation Copy - Quality may be reduced • Carus-Verlag

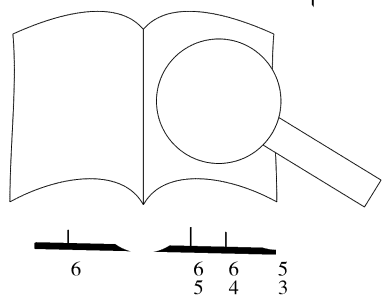

9b. Cum Sancto Spiritu

128 **Vivace**

Tromba I in Re / D

Tromba II in Re / D

Tromba III in Re / D

Corno da caccia

Timpani in Re-La / d-A

Flauto traverso I

Flauto traverso II

Oboe I

Oboe II

Fagotto I, II

Violino I

Violino II

Viola

Soprano I

Soprano II

Continuo

unisono

Cum San-cto Spi - ri - tu, in glo - ri - a De - i

San-cto Spi - ri - tu, in glo - ri - a De - i Pa - tris, in glo - ri - a De - i

Cum San-cto Spi - ri - tu, in glo - ri - a De - i Pa - tris, in glo - ri - a De - i

Cum San-cto Spi - ri - tu, in glo - ri - a De - i Pa - tris, in glo - ri - a De - i

tr

Pa - - - tris, cum San - cto Spi - ri -

Pa - - - tris,

- - - tris, in glo - ri - a De - i Pa - tris,

- - - tris, in glo - ri - a De - i

tr

6 6 6 6 6 7 6
4 4 # 5

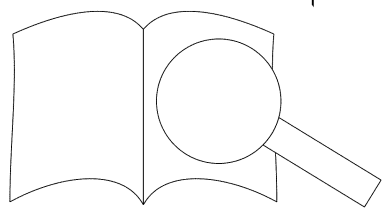

PROBENPAPIER
Ausgabequalität gegenüber Original evtl. gemindert • Evaluation Copy - Quality may be reduced • Carus-Verlag

PROBEKOPPIERUNG

Ausgabequalität gegenüber Original evtl. gemindert • Evaluation Copy - Quality may be reduced • Carus-Verlag

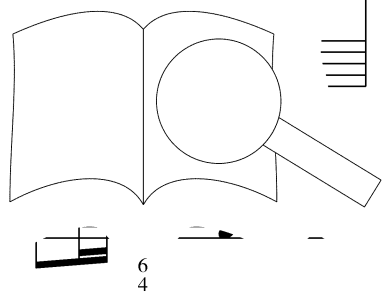

ris, in glo - ri-a De - i Pa - tris, in glo - ri - a

- - - tris, in glo - ri - a

- - - tris,

- - - tris, in glo - ri-a De - i Pa - tris,

- - - tris, cum San-cto S

6
4

6

6

6
5

7
#

6

#

6
5

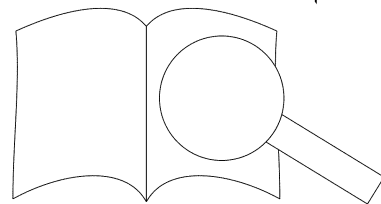

PROBE PAPIER
Ausgabequalität gegenüber Original evtl. gemindert • Evaluation Copy - Quality may be reduced • Carus-Verlag

De - i P
 De
 ri - a De - i Pa - - - tris, in glo - - -
 - - ri - a De - i Pa - - - tris, in glo - - -
 cum San - cto Spi - ri - tu, in glo - -

PROBEKOPPIE
 Original evtl. gemindert • Evaluation Copy - Quality may be reduced • Carus-Verlag

Musical notation for the first system, including vocal line and piano accompaniment.

Musical notation for the second system, including vocal line and piano accompaniment.

Musical notation for the third system, including vocal line and piano accompaniment.

Musical notation for the fourth system, including vocal line and piano accompaniment.

Musical notation for the fifth system, including vocal line and piano accompaniment.

Musical notation for the sixth system, including vocal line and piano accompaniment.

Musical notation for the seventh system, including vocal line and piano accompaniment.

Musical notation for the eighth system, including vocal line and piano accompaniment.

Original evtl. gemindert • Evaluation Copy - Quality may be reduced • Carus-Verlag

ri - a De - i Pa - - - -
 ri - a De - i Pa - - - -
 ri - a De - i Pa - - - -
 ri - a De - i Pa - - - -
 ri - a De - i

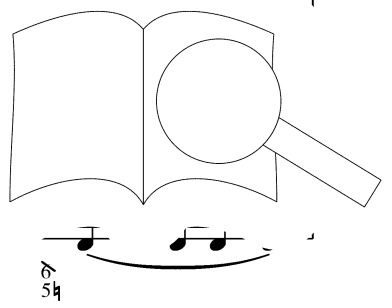

5 7 6 6 5 6 7 6 6 6 4 2 5 4

tris, in glo -

tris, in glo -

tris, in glo -

tris, ir

tris, ii

PROBEPAPIER
 Ausgabequalität gegenüber Original evtl. gemindert • Evaluation Copy - Quality may be reduced • Carus-Verlag

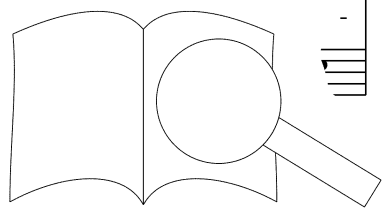

The musical score consists of several systems. The top system includes vocal staves and piano accompaniment. The middle systems are primarily piano accompaniment. The bottom system features vocal lines with lyrics: "ri - a De - i", "ri - a De - i", "ri - a De - i Pa - tris, De - i", and "ri - a De - i".

PROBENPAPIER
 Ausgabequalität gegenüber Original evtl. gemindert • Evaluation Copy - Quality may be reduced • Carus-Verlag

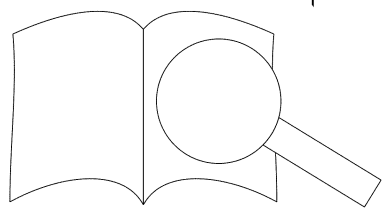

7 7 7 7 7 7 # 6 #

Musical notation for the first system, featuring vocal lines and piano accompaniment.

Musical notation for the second system, featuring vocal lines and piano accompaniment.

Musical notation for the third system, featuring vocal lines and piano accompaniment.

Musical notation for the fourth system, featuring vocal lines and piano accompaniment.

Musical notation for the fifth system, featuring vocal lines and piano accompaniment.

Pa -

Pi -

men.

tris, a - men. Cum San-cto Spi - ri - tu, in glo -

a - tris, a - men.

5 6 7 4 # # 6 # 6 6 6

PROBENPARTITUR
 Ausgabequalität gegenüber Original evtl. gemindert • Evaluation Copy - Quality may be reduced • Carus-Verlag

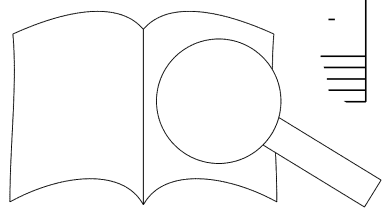

168

Soprano I

Soprano II

Alto

Tenore

Basso

Continuo

Cum San-cto Spi - ri - tu, in glo -

- ri - a De - i Pa - tris, a - men, a -

6 6 6 6 6

173

ri - tu, in

- ri - a De - i Pa - tris, a - men, a -

men, cum San - cto Spi -

7 #

6 5

4 6 5

6 #

178

glo -

- ri - a De - i Pa - tris, a - men, a -

Cum San - cto Spi - ri - tu, in glo -

men, cum San - cto Spi -

1 glo - ri - a De - i Pa - tris, a -

Cum Sai

7 6 [5]

9

8

7

6 5

6

6 6 4

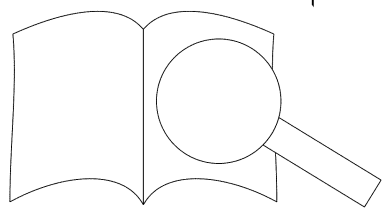

ri-a De - i Pa - tris, a - men, a -
 ri - tu, in glo - ri - a De - i Pa - tris, a - men, a
 glo - ri - a De - i Pa - tris,

6 6 7 6 5 6 7

Fl I
 Fl II
 Ob I
 Ob II
 Fg
 VII
 VI II
 Va

- m - men, a - men.
 men, a - men.
 in glo - ri - a De - i Pa - tris, a - men.
 - men, in glo - ri - a De - i Pa

7 # 6 # 6 6 5 5 7 9 8 6 7 #

PROBE PAPIER
 Ausgabequalität gegenüber Original evtl. gemindert • Evaluation Copy - Quality may be reduced • Carus-Verlag

192

Tr I

Tr II

Tr III

Timp

Fl I

Fl II

Ob I

Ob II

Fg

VII

VI II

Va

A - - men, cum San-cto Spi-ri-

A - - men, cum San-cto Spi-ri-

A - - men, cum San-cto Spi-ri-

A - - men,

A - - men,

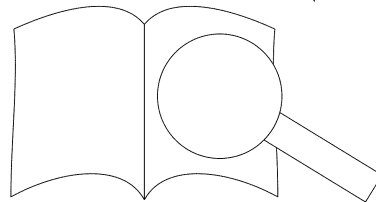

PROBENPAPIER
Ausgabequalität gegenüber Original evtl. gemindert • Evaluation Copy - Quality may be reduced • Carus-Verlag

6

7

7

First system of musical notation, featuring vocal staves with long notes and piano accompaniment.

Second system of musical notation, continuing the vocal and piano parts.

Third system of musical notation, continuing the vocal and piano parts.

Fourth system of musical notation, including lyrics for the vocal parts and piano accompaniment.

tu, a - men, in glo - ri - a De - i Pa - tris, in glo -
 tu, a - men, in glo - ri - a De - i Pa - tris, in glo -
 a - men, in glo - ri - a De - i Pa - tris, in glo -
 a - men, in glo - ri - a De - i in
 a - men, in glo - ri - a D

6 6 6 7 6 7 6
 4 4 5 # 5 # 5

* Siehe / See "Individual Remarks"

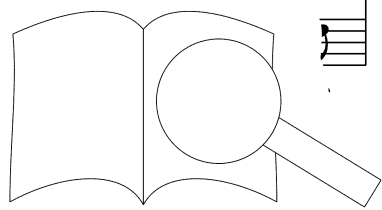
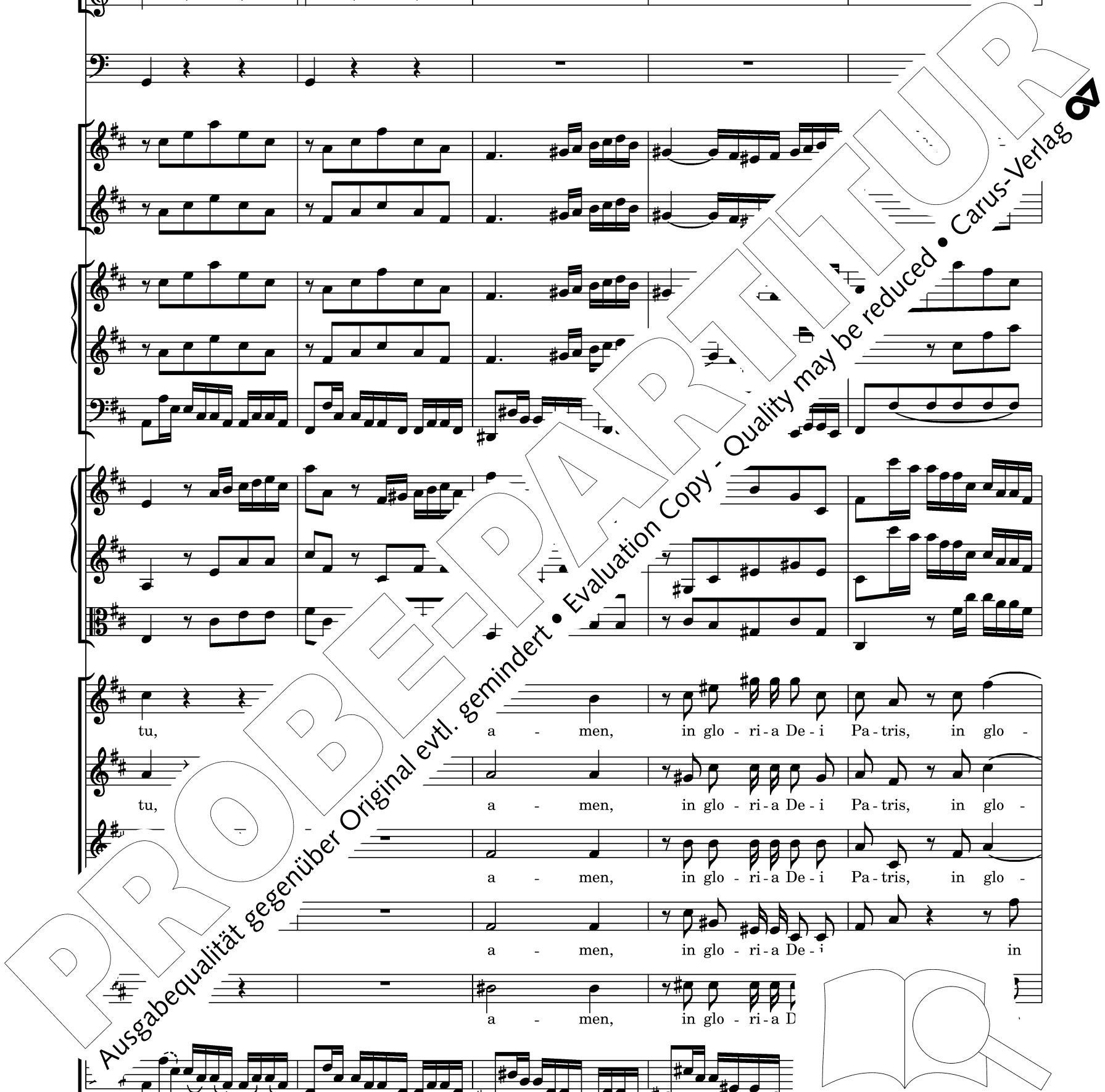

The first system of music consists of three staves. The top two staves are vocal parts, and the bottom staff is the piano accompaniment. The music is in a key with one sharp (F#) and a common time signature. The vocal parts feature a melodic line with eighth and sixteenth notes, while the piano accompaniment provides a rhythmic foundation with eighth notes.

The second system continues the musical piece. It features the same vocal and piano parts as the first system. A small asterisk (*) is placed above the vocal staff in the fourth measure, indicating a specific performance instruction.

The third system shows the continuation of the vocal and piano parts. The piano accompaniment includes some chords with accidentals (sharps and naturals) in the bass line.

The fourth system continues the musical notation. The piano accompaniment features a more active bass line with eighth-note patterns.

The fifth system includes the vocal line with the lyrics "ri - a" and the piano accompaniment. The piano part has a long, sustained chord in the bass line.

The sixth system includes the vocal line with the lyrics "i Pa" and the piano accompaniment. The piano part continues with sustained chords.

The seventh system includes the vocal line with the lyrics "gl e - - i Pa" and the piano accompaniment. The piano part features a long, sustained chord in the bass line.

PROBENPAPIER
Ausgabequalität gegenüber Original evtl. gemindert • Evaluation Copy - Quality may be reduced • Carus-Verlag

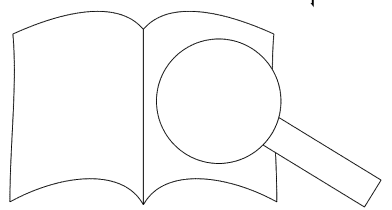

6 4 2 5 6 4 5

* Siehe / See "Individual Remarks"

First system of musical notation, featuring vocal lines and piano accompaniment.

Second system of musical notation, featuring vocal lines and piano accompaniment.

Third system of musical notation, featuring vocal lines and piano accompaniment.

Fourth system of musical notation, featuring vocal lines and piano accompaniment.

Fifth system of musical notation, featuring vocal lines and piano accompaniment.

Sixth system of musical notation, featuring vocal lines and piano accompaniment.

tris.

tris.

Original evtl. gemindert

Cum San - cto Spi - ri - tu, in glo - - -

ri - a De - i Pa - tris.

in glo - ri - a De - i Pa - tris.

in glo - ri - a De - i Pa - tris.

in glo - ri - a De - i Pa - tris.

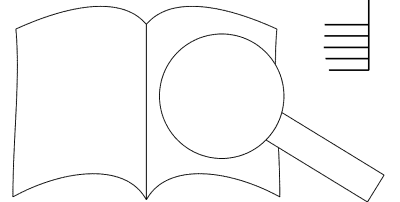

δ 4 2 6 6 6 δ # 6 7 - 6 7 - 6 5

PROBENPAPIER
Ausgabequalität gegenüber Original evtl. gemindert • Evaluation Copy - Quality may be reduced • Carus-Verlag

- ri-a De-i Pa

1. pi-ri - tu, in glo - - - ri-a De - i

Cum San-cto Spi - ri - tu, in glo - - -

Cum San-cto Spi-ri - tu,

Cum San - cto Spi-ri - tu, in glo

7 # - 6 5 6 6 6 6 6 6 6 5 6 4 2 6

PROBEKOPPIERT
 Ausgabequalität gegenüber Original evtl. gemindert • Evaluation Copy - Quality may be reduced • Carus-Verlag

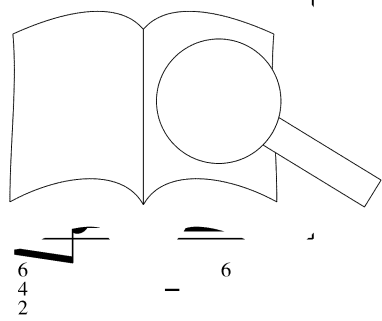

Pa - - - - - cum San - cto Spi - ri - tu, in glo -

am San - cto Spi - ri - tu, in glo - - - - ri - a De - i

ris, a - men, a - - - - -

cum San - cto Spi - - ri - tu, in glo - - - -

- - tris, De - i Pa - tris, cum San - cto Spi - ri - tu,

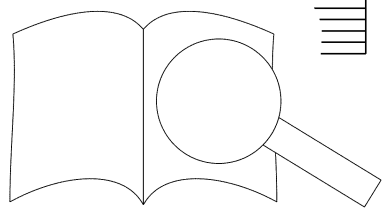

PROBEPAPIER

Ausgabequalität gegenüber Original evtl. gemindert • Evaluation Copy - Quality may be reduced • Carus-Verlag

9 7 6 5 7 # 7 # 6 6 # 6 6 5 6 4 6 6 6

PROBEKOPPIERUNG
 Ausgabqualität gegenüber Original evtl. gemindert • Evaluation Copy - Quality may be reduced • Carus-Verlag

gl

to - - ri - a De - i Pa - tris, a - men, a -

to - - ri - a De - i Pa - tris, a - men, a - - - men,

7 - 8 7 9 7 6 6 6 5 7 7 8 7 5 6

PROBEKOPPIERUNG
 Ausgabequalität gegenüber Original evtl. gemindert • Evaluation Copy - Quality may be reduced • Carus-Verlag

- ri - tu, in

ra - - - tris, a

- ri - tu, in glo - - ri - a De - i Pa - tris, a - - - men,

- men, a

- - ri - tu, in glo - - - glo

6 6 - 6 5 \sharp 7 - 4 6 5 \sharp - 7 \sharp 7 6

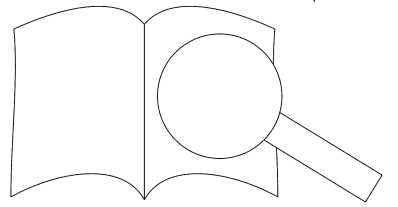

PROBEKOPPIERT
Ausgabequalität gegenüber Original evtl. gemindert • Evaluation Copy - Quality may be reduced • Carus-Verlag

men, in g i Pa-tris, a-men, in glo - - ri-a De - i Pa-tris,

mer

- - - men, a - - - - - men,

men, a - - - - - men, a - - - - - men,

- men, cum San - cto Spi - - ri - tu, in glo - ri-a De - i Pa - tris,

6 6 7 7 6 7

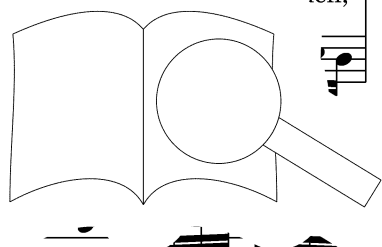

DROBEPAPIER • Evaluation Copy - Quality may be reduced • Carus-Verlag

3 # 6 6 5 6 6 5 6 4 2 5/4

PROBEKOPPIE
 Ausgabqualität gegenüber Original evtl. gemindert • Evaluation Copy - Quality may be reduced • Carus-Verlag

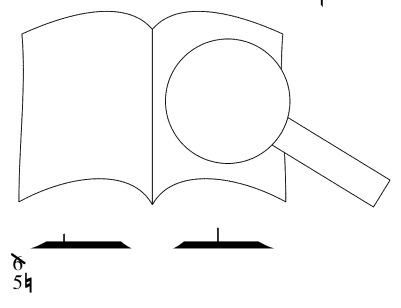

6h
4

7h
5

6
4
2

6

5

6

PROBEKOPPIE
 Original evtl. gemindert • Evaluation Copy - Quality may be reduced • Carus-Verlag

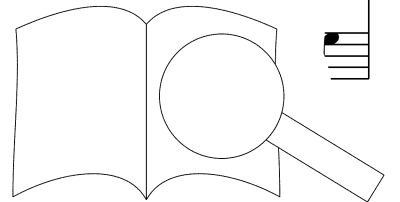

Musical notation for the first system, including vocal line and piano accompaniment.

Musical notation for the second system, including vocal line and piano accompaniment.

Musical notation for the third system, including vocal line and piano accompaniment.

Musical notation for the fourth system, including vocal line and piano accompaniment.

Musical notation for the fifth system, including vocal line and piano accompaniment.

Musical notation for the sixth system, including vocal line with lyrics and piano accompaniment.

Musical notation for the seventh system, including vocal line with lyrics and piano accompaniment.

Musical notation for the eighth system, including vocal line with lyrics and piano accompaniment.

Musical notation for the ninth system, including vocal line with lyrics and piano accompaniment.

PROBE
Ausgabequalität gegenüber Original evtl. gemindert • Evaluation Copy - Quality may be reduced • Carus-Verlag

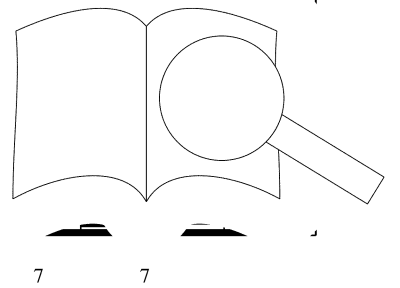

First system of musical notation, featuring a vocal line with a triplet of eighth notes and piano accompaniment.

Second system of musical notation, continuing the vocal and piano parts.

Third system of musical notation, continuing the vocal and piano parts.

Fourth system of musical notation, continuing the vocal and piano parts.

Fifth system of musical notation, including the start of the lyrics: "tris, a - men, in glo - ri - a De - i Pa - tris, a - men."

Sixth system of musical notation, including the lyrics: "s, a - men, in glo - ri - a De - i Pa - tris, a - men."

Seventh system of musical notation, including the lyrics: "i Pa - tris, De - i Pa - tris, a - men, in glo - ri - a De - i Pa - tris, a - men, in glo - ri - a D"

PROBEKOPPIE
 Original evtl. gemindert • Evaluation Copy - Quality may be reduced • Carus-Verlag

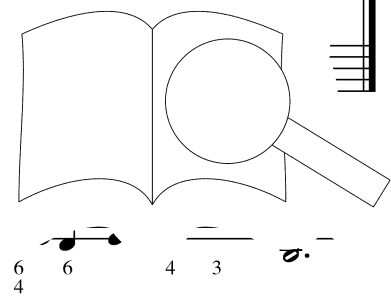

II. Symbolum Nicenum

10. Credo in unum Deum

Violino I

Violino II

Soprano I

Soprano II

Alto

Tenore

Basso

Continuo

Cre - - - do in u - - - num, in

Cre - - -

The score shows the beginning of the piece. The vocal parts (Soprano I, Soprano II, Alto, Tenore, Basso) are mostly silent, with the Tenore part starting with the lyrics 'Cre - - - do in u - - - num, in'. The Continuo part has a rhythmic pattern of eighth notes.

5

Cre - - -

- - - do in u - - - num De - - - um, - - -

um, - - - in u - - - num De - - - um, in u - - - num De - - -

in u - - - num De - - - um, in u - - - num De - - - un

5 7 6 5 6 6 5 7 4 4 3 5

6 4 6 5 7 4 4 3 5

The score continues with the vocal parts. The lyrics are: 'Cre - - - do in u - - - num De - - - um, - - - um, - - - in u - - - num De - - - um, in u - - - num De - - - in u - - - num De - - - un'. The Continuo part continues with a similar rhythmic pattern. There are fingerings indicated below the Continuo staff.

do in u - num De - um, in u - num De - um, in u

Cre - - - do in

cre - do in u - num De - um, in u - num De - um, in Je

- num De - um, in u - num De - um, cre - do in in

um, in u - num De - - - - um, - in u - num De -

9 7 6 5 4 9 6 4 # 6 -

um, cre - - - u - num De - um, in u - num De - - -

De n, u - um, in u - num De - - um, in u - num De - um,

- num De - - - - um, cre - do in

- um, cre

- um, in u - num De - - - - um, cre -

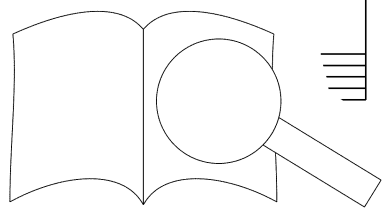

20

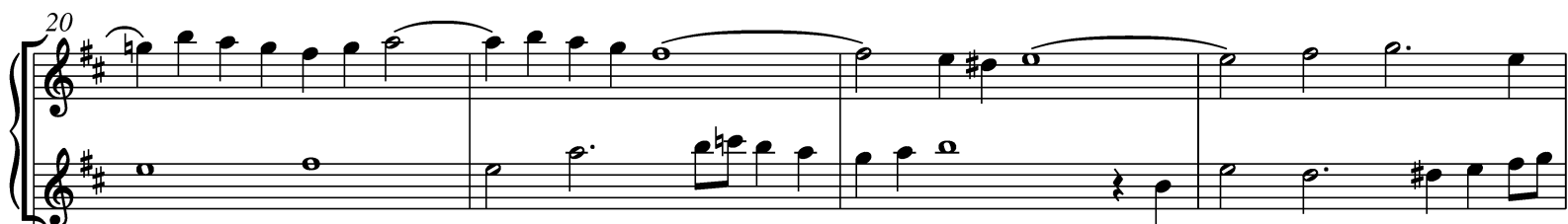

um, cre - - do in u-num De - um, in u-num De - um,
in u - num De - um,
u - - num De - um, cre - - do
in u - - num De - - um, in u - - num De - - um,
um, cre - do, cre - - do

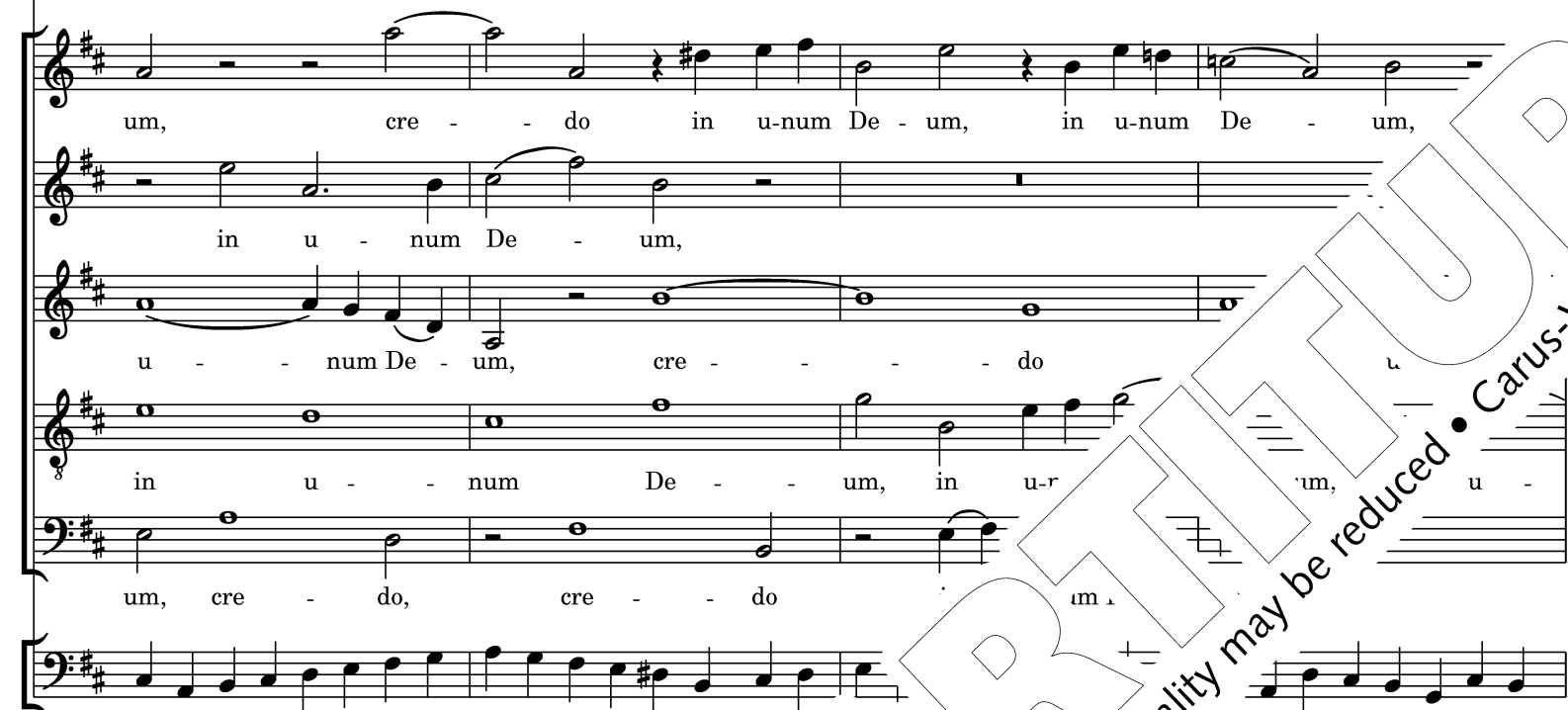

24



cre - - do in
- do in u - num De - -
um, in u-num De - um, in u - num De - um, in u -
um, in u - - num De - - um, cre -
cre - - do in u - num De - - um, cre - do



u - num De - um, cre - do in u-num De - um, cre

um, in u-num De - um, cre - do in u-num De -
 num De - um, in u - num De -
 u - num De - um, in u - num De - u
 in u - num De - um, um - um,

u-nur um De - um, cre - do in
 .m, in u - num De - um, cre - do in
 u - num De - um, cre - do in
 cre - do in u-num De - um,
 cre -

PROBENPAPIER
 Ausgabequalität gegenüber Original evtl. gemindert • Evaluation Copy - Quality may be reduced • Carus-Verlag

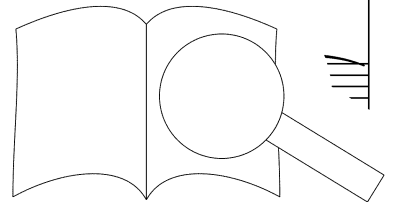

u - num De - um, in u - num De - - um, cre
 u - num De - um, cre - do, cre - do in u -
 u - num De - um, cre - do
 in u - num De - um, cre - do, cre - do
 in u - - - num - um,

in u - nu - do in u - num De - - - um.
 um, in - um, cre - do in u - num De - - - um.
 - - - um, cre - do in u - num De - - - um.
 am De - um, cre - do, cre - do in u - nu
 in u - num, in u - num, in u - num De -

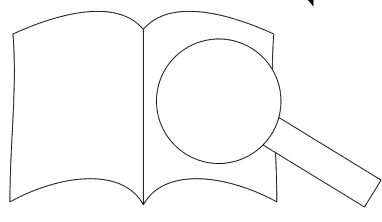

PROBENUR

Ausgabequalität gegenüber Original evtl. gemindert • Evaluation Copy - Quality may be reduced • Carus-Verlag

11. Patrem omnipotentem

Tromba I
in Re / D

Tromba II
in Re / D

Tromba III
in Re / D

Timpani
in Re-La / d-A

Oboe I

Oboe II

Violino I

Violino II

Viola

Soprano I, II

Alto

Continuo

u-num De-um, cre - do

in u-num De-um, cre - do

re - do in u-num De-um, cre - do

Pa - trem o - mni-pot - en - tem, fa-cto-rem coe - li et tu n



7

Ob I

Ob II

VII

VI II

Va

in u - num De - um, cre - do in r

in u - num De - um, cre - do P- ot

8 Pa - trem o - mni - pot - en - tem, fa - cto - rem coe - li fa -

coe - li et ter - rae, fa - cto - - li rae, vi - si - bi -

13

Pa - trem o - mni - pot - en -

oe - li et ter - - rae, fa - cto - rem coe - li et ter - rae, fa -

cto - - rem coe - li et ter - rae, vi - si - bi - - li - um o

li - um o - - mni - um, et in - vi - si - bi - li - um,

tem, fa - cto-rem coe - li et ter - - rae, fa - cto -
cto - - - rem coe - li et ter - rae, fa - cto -
- li-um o - - mni-um, et in - vi - si - bi - li - um, fa
Pa - trem o - - - rem coe - li et

Tr I

fa - cto - - - rem coe - li et ter - rae, vi-si-
- rae, vi-si-bi - - li-um o - - mni-um, et in-vi-si-
- li et ter - rae, vi-si - bi - li - um o - mni-um, et in - vi-
ter - - - rae, fa - cto - - - rem - coe - li et

PROBENPAPIER

Ausgabequalität gegenüber Original evtl. gemindert • Evaluation Copy - Quality may be reduced • Carus-Verlag

bi - - li - um o - - - - - rem coe - - - - - ae, si -
 fa - cto - - - - - rem coe - li - e - - - - - si - bi - li -
 cto - - - - - rem coe - - - - - li - - - - - bi - li - um o -

vi - si - bi - - - - - li - um, Pa - trem o - mni - pot - en - - - - - tem, fa - cto - rem
 i - - - - - ani - um, et in - vi - - si - bi - - li - um,
 - - - - - mni - um, et in - vi - si - bi - li - um,
 - mni - um, et in - vi - si - bi - li - um, et in - vi - si - bi - li - um,

PROBENPAPIER
 Original evtl. gemindert • Evaluation Copy - Quality may be reduced • Carus-Verlag

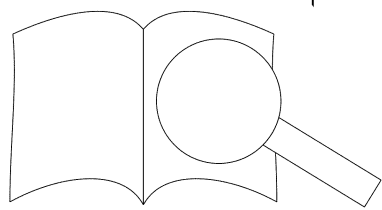

coe - li et ter - - - rae, fa - cto -
 cre - do, Pa - trem o - mni - pot - en - tem, fa - cto -
 cre - do in u - num De - um, Pa - trem o -
 cre - do in u - num De - um,

Ob I
 Ob II
 - - - rem coe - li et ter - rae, vi - si - bi - li - um o -
 cto - - - rem coe - li et ter - rae, vi - si - bi - li -
 en - tem, fa - cto - rem coe - li et ter - - rae,
 cre - do in u - num De - um, Pa - trem o - mni - pot -

PROBENPAPIER
 Ausgabqualität gegenüber Original evtl. gemindert • Evaluation Copy - Quality may be reduced • Carus-Verlag

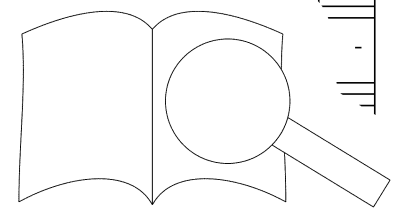

54

mni-um, e'
 um, et in - vi - si - bi - - li - um o -
 - rem coe - li et ter - - rae, vi - si -
 coe - li et ter - rae, coe - li rae, - li et

59

- - rem coe - - li et - - rae, Pa - trem o -
 - li - um et in - vi - si - bi - li - um o - - - mni -
 um,
 - - rem coe
 - - rae, vi - si - bi - - li - um o - - mni - um, et in - v

65

Tr I

Tr II

Tr III

Timp

mni-pot - er - li et ter - rae, vi-si-bi - li-um o-mni - um, et

li et ter - rae, et ter - rae, vi-si - bi-li-um o-mni - um,

rem coe - li et ter - rae, vi-si-bi - in - vi - si - bi - li - um,

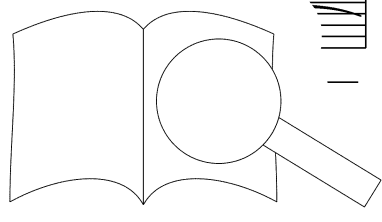

PROBENPARTITUR
Ausgabequalität gegenüber Original evtl. gemindert • Evaluation Copy - Quality may be reduced • Carus-Verlag

in - vi - si - bi - li - um, vi - si - bi - li - um et in - vi - si - bi - li -
 si - bi - li - um, vi - si - bi - li - um o -
 1, et in - vi - si - bi - li - um, et in - vi - si - bi - li - um, vi - si - bi - li -
 bi - li - um o - mni - um, et i

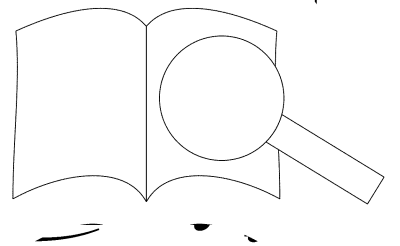

PROBENPAPIER
 Ausgabqualität gegenüber Original evtl. gemindert • Evaluation Copy - Quality may be reduced • Carus-Verlag

First system of musical notation, featuring a vocal line and piano accompaniment.

Second system of musical notation, featuring a vocal line and piano accompaniment.

Third system of musical notation, featuring a vocal line and piano accompaniment.

Fourth system of musical notation, featuring a vocal line and piano accompaniment.

Fifth system of musical notation, featuring a vocal line and piano accompaniment.

um, vi-si -

- mni - um, et in-vi - si - bi - li - um.

- mni-um, et in - vi - si - bi - li - um.

- mni - um, et in - vi - si - bi - li - um.

- mni - um, et in - v

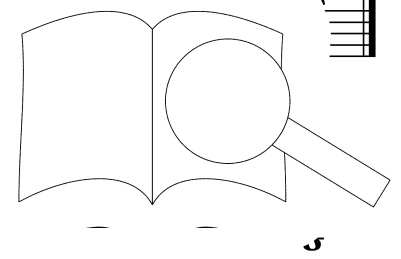

PROBEPARTITUR
 Ausgabequalität gegenüber Original evtl. gemindert • Evaluation Copy - Quality may be reduced • Carus-Verlag

12. Et in unum Dominum

Andante

Oboe I *
Violino I

Oboe II *
Violino II

Viola

Soprano I

Alto

Continuo

5

9

olo

Violino solo

12

am, in u-num Do -

in u-num, in u-num Do -

15

* Zur Besetzung mit Oboen siehe die „Hinweise zur Notation und Aufführungspraxis“. / Concerning scoring with oboes, see the "Issues of notation and performance practice."

13 Oboe e Violino

Oboe e Violino

- - - mi-num Je - - - sum Chri - stum, Je - sum, Je -

- - - mi-num Je - - - sum Chri - stum, Je

17 * Violino solo

* Violino solo

Violino solo

stum, Fi - li - um De - i - u - ni - et in u - num

stum, e - i - u - ni - ge - ni - tum, et in u - num

20

- - - mi-num Je - sum Chri - stum, Je

Do - - - mi-num Je - sum Chri - stum,

* Ob I besser ♪ / Ob I better ♪

23

Chri-stum, et in u-num Do - mi-num, in u-num Do - mi-num Je - sum Chri - st
- sum Chri-stum, et in u - num Do - mi-num, in u - num Do - mi-n'

26

li-um De - i u -
Fi - li-um De - ni - tum.

Obr

30

ni - tum.

PROBEKOPPIE
Ausgabequalität gegenüber Original evtl. gemindert • Evaluation Copy - Quality may be reduced • Carus-Verlag

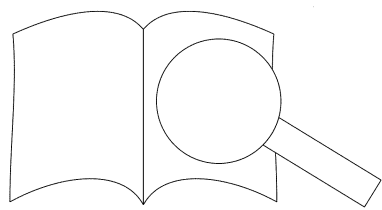

34

Violino solo

Violino solo

Et ex Pa-tre, ex Pa-tre na - tum, et ex Pa-tre, ex Pa-tre na

Et ex Pa-tre, ex Pa-tre na - - - tum, et ex Pa-tre,

6 4 6
4 2 6

38

o - - - m - cu-la, an-te o - mni-a sae - - cu -

- tum an-te o - - - ae - - - cu-la, an-te o-mni-a sae-cu-

tr

tr

42

Oboe e Vi...

Vi.

la.

47

Violino solo

Violino solo

De-um de De-o, lu-men de lu - - - mi-ne, De

De-um de De-o, lu-men de lu - mi-ne,

51

de De-o ve - - - ro. Ge-ni-t sub-stan-ti-a-lem Pa - - -

De-o ve - ro. Ge-ni-tum, n - - - ti - a-lem Pa - - - tri: per quem

55

quem o-mni-a fa-cta sunt, De-um ve-rum de De-o ve - 1

- mni-a fa - - - cta - - - sunt, De-um ve-rum de De-o ve -

59

ve - - - ro, per quem o - - - mni - a fa - cta, fa - cta
 ve - - - ro, per quem o - - - mni - a fa -

63 Oboe e Violino

nes, et pro-pter no-stram sa-
 er r et pro-pter no-stram sa-lu-tem, pro-pter

67

pro-pter no-stram sa-lu-tem de-scen-dit de ser
 no-stram sa-lu-tem de-scen-dit de coe-lis,

70

nos, et pro-pter no - stram sa - lu - tem de - scen - dit, de - scen - dit, de - scen -
no - stram sa - lu - tem de - scen - dit de coe - lis, qui pro-pte

73

coe - - lis, et qui pro-pter n cen - - dit de coe - lis.
- dit de coe - lis, em - de - scen - dit de coe - - lis.

77

PROBEKOPPIERT
Ausgabequalität gegenüber Original evtl. gemindert • Evaluation Copy - Quality may be reduced • Carus-Verlag

13. Et incarnatus est

Violino I, II

Soprano I

Soprano II

Alto

Tenore

Basso

Continuo

* Im Autograph eis; siehe "Individual Remarks". / The autograph has e sharp; see "Individual Remarks."

13

cto ex Ma - ri - a Vir - gi - ne, ex Ma - ri - a

cto ex Ma - ri - a Vir - gi - ne, ex Ma - ri - a, Ma -

cto ex Ma - ri - a Vir - gi - ne, ex M^r

cto ex Ma - ri - a Vir - gi - ne,

cto ex Ma - ri - a Vir - gi ex .i - a

19

Vir - gi

Vir

ne, et in - car -

gi - ne, et in - car -

* Siehe / See "Individual Remarks"

PROBEPARTITUR

Ausgabequalität gegenüber Original evtl. gemindert • Evaluation Copy - Quality may be reduced • Carus-Verlag

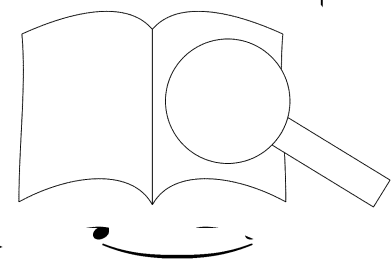

25

et in - car - na - - - tus est de Spi - ri -
 et in - car - na - tus est, in - car - na - tus est de
 na - - - tus est, in - car - na - tus est
 est, in - car - na - tus est, in - car - na - tus ri -
 et in - car - na - spi - ri -
 simile

31

San - - - Ma - ri - a Vir - - - gi -
 tu - ri - a Vir - gi - ne, ex Ma - ri - a,
 ex Ma - ri - a Vir - gi - ne, ex Ma - ri - a,
 - cto ex Ma - ri - a Vir - Ma -
 San - - cto ex Ma - ri - a Vir

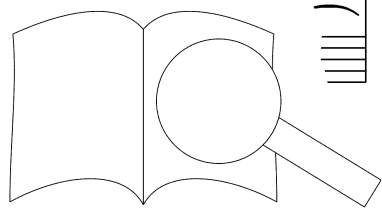

37

ne, ex Ma-ri - a Vir - gi - ne: Et ho - mo
 ex Ma - ri - a Vir - gi - ne: Et ho
 ex Ma - ri - a Vir - gi - ne:
 ri - - a Vir - gi - ne:
 - ri - a Vir - gi - ne:

43 VII

VI II

fa - ctus fa - ctus est.
 et ho - mo, ho - mo fa - ctus est.
 s est, et ho - mo, ho - mo fa - ctus est.
 o mo, ho - mo - mo
 a - ctus est, ho - mo

14. Crucifixus

Flauto traverso I

Flauto traverso II

Violino I

Violino II

Viola

Soprano II

Alto

Tenore

Basso

Continuo

This system contains the first six measures of the 'Crucifixus' movement. It features two flutes (I and II), two violins (I and II), a viola, and a continuo. The vocal parts for Soprano II, Alto, Tenore, and Basso are present but mostly contain rests. The lyrics 'Cru - ci -' are written under the Alto part in the sixth measure.

7

This system contains measures 7 through 12. The vocal parts enter with the lyrics 'cru - ci - fi - xus,' in measure 7. The lyrics continue as 'cru - ci - fi - xus,' in measure 8, 'cru - ci - fi - xus,' in measure 9, and 'Cru - ci - fi - xus,' in measure 10. The lyrics 'cru - ci -' are written under the Alto part in measure 11. The continuo part continues with a steady rhythmic accompaniment.

cru - ci - fi - xus et - i - am pro no - bis,
 fi - xus, cru - ci - fi - xus et - i - am pro
 cru - ci - fi i - am pro
 cru - ci - fi - xu ci - fi - xus et -

- i - am pro no - - - bis: sub Pon - ti -
 - am pro no - - - bis: sub Pon - ti - o Pi - la - to,
 et - - i - am pro
 i - am pro no - - - - - bis:

PROBENPAPIER

Ausgabequalität gegenüber Original evtl. gemindert • Evaluation Copy - Quality may be reduced • Carus-Verlag

o Pi - la - to pas - - sus et se - pul -
 sub Pon - ti - o Pi - la - to pas - - sus et
 Pon - ti - o Pi - la - - to pas - sus, pas - tu - s est, pas -
 o Pi - la - - to pas - - tus est, pas -

- tus est, cru - - ci - fi - xus et - i - am pro -
 se - pul - tus est, cru -
 et se - pul - tus est,
 sus et se - pul - tus est,

PROBENPAPIER
 Ausgabequalität gegenüber Original evtl. gemindert • Evaluation Copy - Quality may be reduced • Carus-Verlag

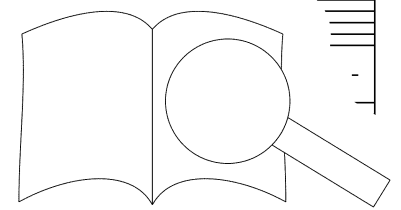

no - bis: sub Pon-ti-o Pi-la - - - to pas -
 - xus et - i-am pro no - bis: sub Pon - ti-o Pi - la - - - to
 fi - xus et - i-ar - - - bi - - - as - sus
 - - - ci - fi - xus et - i-am pro no - - - bi -

cus est, se - pul - tus est, se - pul - tus est.
 - pul - tus est, pas - - - sus et se - pul - tus est.
 - pul - tus est, se - pul - - - tus, se -
 pas - sus et se-pul - tus est, se - pul - tus est, et se -

PROBEPAPIER
 Ausgabequalität gegenüber Original evtl. gemindert • Evaluation Copy - Quality may be reduced • Carus-Verlag

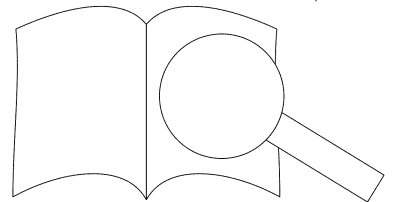

15. Et resurrexit

Tromba I
in Re / D

Tromba II
in Re / D

Tromba III
in Re / D

Timpani
in Re-La / d-A

Flauto traverso I

Flauto traverso II

Oboe I

Oboe II

Violino I

Violino II

Viola

Soprano I

Soprano II

Alto

Contralto

Et re-sur - re - xit, re - sur - re - xit,

Et re-sur - re - xit, re - sur - re - xit,

Et re-sur - re - xit, re - sur - re - xit,

Et re-sur - re - xit, re - sur - re - xit,

* Für Flauto I, II T. 3-4 vgl. T. 88-89 und siehe die „Hinweise zur Notation und Aufführungspraxis“.
Concerning Flauto I, II in mm. 3-4, compare mm. 88-89 and see the "Issues of notation and performance practice."

5

Musical notation for the first system, including vocal line and piano accompaniment. The vocal line starts with a treble clef and a key signature of two sharps (F# and C#). The piano accompaniment is in bass clef. The system contains five measures.

Musical notation for the second system, including vocal line and piano accompaniment. The vocal line continues with a treble clef and a key signature of two sharps. The piano accompaniment is in bass clef. The system contains five measures.

Musical notation for the third system, including vocal line and piano accompaniment. The vocal line continues with a treble clef and a key signature of two sharps. The piano accompaniment is in bass clef. The system contains five measures.

Musical notation for the fourth system, including vocal line and piano accompaniment. The vocal line continues with a treble clef and a key signature of two sharps. The piano accompaniment is in bass clef. The system contains five measures.

Five empty musical staves for the fifth system, including vocal line and piano accompaniment. The staves are empty, indicating a section where the music is not present or has been removed.

Musical notation for the sixth system, including vocal line and piano accompaniment. The vocal line continues with a treble clef and a key signature of two sharps. The piano accompaniment is in bass clef. The system contains five measures.

PROBEKOPPIE
Ausgabequalität gegenüber Original evtl. gemindert • Evaluation Copy - Quality may be reduced • Carus-Verlag

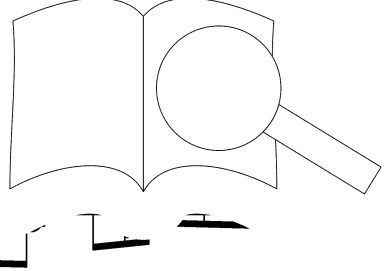

et re-sur-
 et re-sur - re - - - - xit, re-sur-
 re - - - - xit, re-sur-
 et re-sur - re - - - - xit, re-sur-

xit, re-sur - re-xit, 1

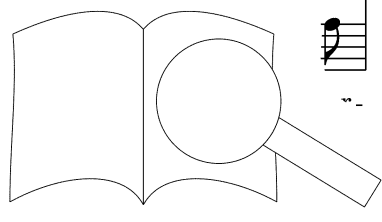

PROBEPARTITUR

Ausgabequalität gegenüber Original evtl. gemindert • Evaluation Copy - Quality may be reduced • Carus-Verlag

Musical notation for the first system, including vocal line and piano accompaniment. The piano part features a triplet of eighth notes in the right hand.

Musical notation for the second system, including vocal line and piano accompaniment. The piano part continues with triplet figures.

Musical notation for the third system, including vocal line and piano accompaniment. The piano part continues with triplet figures.

Musical notation for the fourth system, including vocal line and piano accompaniment. The piano part continues with triplet figures.

Musical notation for the fifth system, including vocal line and piano accompaniment. The piano part continues with triplet figures.

re - xit, re-sur - re - xit ter - ti - a di - e, re - sur - re - xit ter - ti - a
 re - xit ter - ti - a di - e, re - sur - re - xit ter - ti - a
 - - - xit ter - ti - a di - e, et re - sur - re - xit ter - ti - a
 - - - - sur - re - - - - xit ter - ti - a di - e, re - sur
 xit, re - sur - re - - - - xit - ter - ti - a di - e, et re - sur

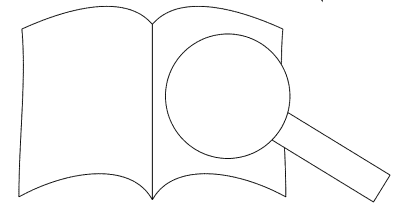

PROBENPAPIER
 Original evtl. gemindert • Evaluation Copy - Quality may be reduced • Carus-Verlag

di-e, et r - xit, — et re-sur-re-xit, re-sur-re-xit, re-sur-

di-e. ., re-sur-re-xit, — et re-sur-re-xit, re-sur-re-xit, re-sur-

-xit, re-sur-re-xit, et re-sur-re-xit, re-sur-re-xit, re-sur-

-sur-re-xit, re-sur-re-xit, — et re-sur-re-xit, re-sur-re-xit, re-sur-

et re-sur-re-xit, re-sur-re-xit, et re-sur-re-xit, re - ur-

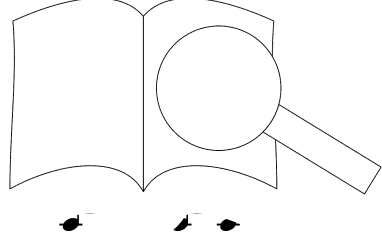

PROBEPAPIER
 Ausgabqualität gegenüber Original evtl. gemindert • Evaluation Copy - Quality may be reduced • Carus-Verlag

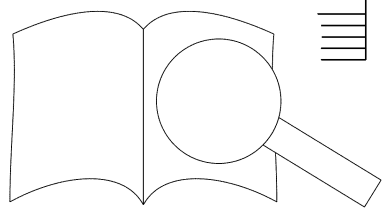

PROBENPAPIER
Ausgabequalität gegenüber Original evtl. gemindert • Evaluation Copy - Quality may be reduced • Carus-Verlag

35 Fl I
Fl II
Ob I
Ob II

40

45

Tr I

Tr II

Tr III

Timp

Musical notation for Tr I, Tr II, Tr III, and Timp. Tr I, Tr II, and Tr III are in treble clef. Timp is in bass clef. The notation shows rests for the first three measures and then rhythmic patterns in the fourth measure.

Musical notation for piano accompaniment, consisting of four staves. The first two staves are in treble clef, and the last two are in bass clef. The music features a complex rhythmic pattern with many sixteenth notes.

Musical notation for piano accompaniment, consisting of four staves. The first two staves are in treble clef, and the last two are in bass clef. The music continues with a complex rhythmic pattern.

Empty musical staves for piano accompaniment, consisting of four staves (two treble and two bass clefs).

Empty musical staves for piano accompaniment, consisting of four staves (two treble and two bass clefs).

Musical notation for piano accompaniment, consisting of four staves. The first two staves are in treble clef, and the last two are in bass clef. The notation shows rhythmic patterns in the first measure.

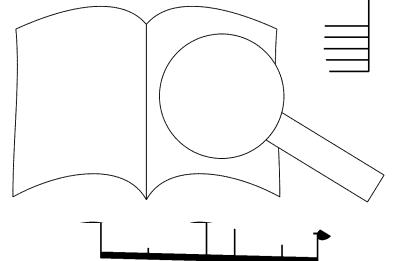

PROBENPAPIER
 Ausgabequalität gegenüber Original evtl. gemindert • Evaluation Copy - Quality may be reduced • Carus-Verlag

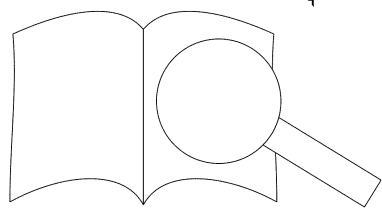

PROBENPARTITUR

Ausgabequalität gegenüber Original evtl. gemindert • Evaluation Copy - Quality may be reduced • Carus-Verlag

De - i a - scen - dit, a-scen-dit in
 De a-scen-dit, a - scen-dit in
 a - scen-dit in
 - tris, a - scen-dit in
 an De-i Pa - tris,

* Siehe / See "Individual Remarks"

PROBENPAPIER

Ausgabequalität gegenüber Original evtl. gemindert • Evaluation Copy - Quality may be reduced • Carus-Verlag

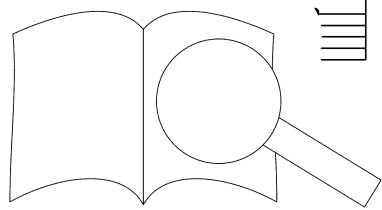

Three staves of musical notation, all containing rests.

Four staves of musical notation. The top two staves contain piano accompaniment with triplets (marked '3'). The bottom two staves contain rests.

Four staves of musical notation. The top two staves contain piano accompaniment. The bottom two staves contain rests.

Vocal line with Latin lyrics:

coe-lum, — i: — se - det — ad dex - te-ram De-i — Pa -

coe - lum: se - det ad dex - - -

dit in coe - lum: se - det, se - det ad

scen - dit in coe - lum: se - - det ad dex -

um, a - scen - dit in coe - lum: se - det ad de

* Siehe / See "Individual Remarks"

PROBENPAPIER
Ausgabequalität gegenüber Original evtl. gemindert • Evaluation Copy - Quality may be reduced • Carus-Verlag

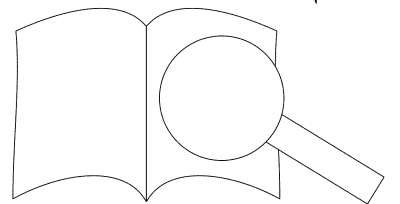

Empty musical staves for vocal or instrumental parts, consisting of three systems of two staves each.

First system of piano accompaniment. It features a grand staff with four staves. The music includes eighth and sixteenth notes, with several triplet markings (indicated by a '3' over a group of notes).

Second system of piano accompaniment, continuing the musical notation from the first system.

Third system of piano accompaniment, continuing the musical notation.

Vocal line with lyrics. The lyrics are: "Je - i Pa - tris. Je - - i Pa - tris." The notes are placed above the lyrics.

Bass line musical notation, consisting of a single staff with notes and rests.

PROBEKOPPIERT
 Ausgabequalität gegenüber Original evtl. gemindert • Evaluation Copy - Quality may be reduced • Carus-Verlag

75 VI I
 VI II
 Va

rum ven - tu-rus est cum glo-ri - a, ven-tu - rus cum glo - ju - di-ca -

80

- re vi-vos et mor - tu-os, ju - di-ca

* Siehe / See "Individual Remarks"

85

Tr I

Tr II

Tr III

Timp

Musical notation for Tr I, Tr II, Tr III, and Timp. The Tr I part has a triplet of eighth notes. The Timp part has a steady eighth-note accompaniment.

Musical notation for the first system of the piano accompaniment, featuring a complex texture with multiple voices and triplets.

Musical notation for the second system of the piano accompaniment, continuing the complex texture with triplets.

Vocal line with lyrics: non e - rit fi - nis, jus re - gni non e - rit fi - nis, cu - jus re - gni non e - rit fi - nis, cu - jus re - gni non e - rit fi - nis,

Musical notation for the piano accompaniment and vocal line with lyrics: - vos et mor - tu - os: cu - jus re - gni non e - rit fi - nis,

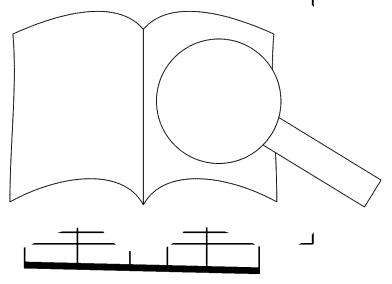

PROBENPAPIER
Ausgabequalität gegenüber Original evtl. gemindert • Evaluation Copy - Quality may be reduced • Carus-Verlag

cu - jus re - - -

cu - jus re - -

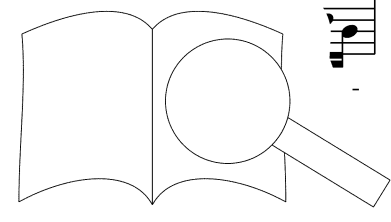

PROBENPAPIER
 Ausgabequalität gegenüber Original evtl. gemindert • Evaluation Copy - Quality may be reduced • Carus-Verlag

cu - jus re-gni — non e-rit fi-nis, — cu - jus
 - - - gni, cu - jus re-gni — non e-rit fi-nis, — cu - jus
 - - - gni non e - rit fi - nis, non e-rit fi - nis, cu - jus
 - - - gni non e - rit fi - nis, non e-rit fi - nis, cu - jus
 - non e - rit fi-nis, non e - rit fi-nis, cu - jus re - gni non e

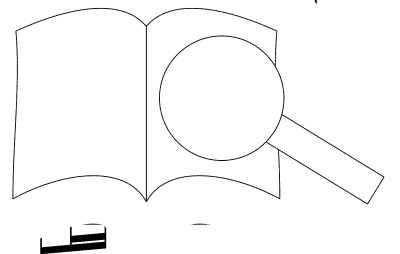

* Siehe / See "Individual Remarks"

Musical score for the first system, featuring three staves with treble clefs and a bass staff. The music includes triplets and trills.

Musical score for the second system, featuring three staves with treble clefs and a bass staff. The music includes trills and triplets.

Musical score for the third system, featuring three staves with treble clefs and a bass staff. The music includes trills and triplets.

re-gni — nor
 re
 cu - jus re - - - - - gni non e-rit
 nis, cu - jus re - - - - -
 e-rit fi - nis, cu - jus re - - - - - gni, cu - - - - - rit
 - gni non e-rit fi - nis, cu - jus re - - - - -

PROBEKOPPIE
 Ausgabqualität gegenüber Original evtl. gemindert • Evaluation Copy - Quality may be reduced • Carus-Verlag

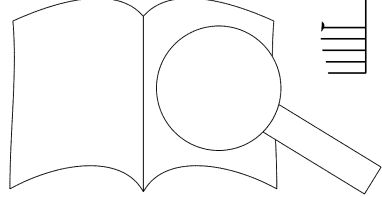

tr

tr

tr

tr

3

3

fi - nis, cu - jus re - gni non e - rit

fi - nis, cu - jus re - gni non e - rit

gnis, cu - jus re - gni non e - rit

gnis, cu - jus re - gni non e - rit

PROBEKOPPIE
 Ausgabqualität gegenüber Original evtl. gemindert • Evaluation Copy - Quality may be reduced • Carus-Verlag

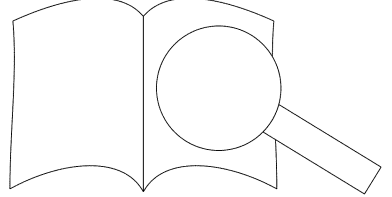

Musical score for three voices (Soprano, Alto, Tenor) and bass, measures 109-112. The music is in a major key with a common time signature. The Soprano part features a melodic line with eighth and sixteenth notes. The Alto and Tenor parts provide harmonic support with similar rhythmic patterns. The Bass part has a more active, rhythmic accompaniment.

Musical score for piano accompaniment, measures 109-112. The piano part consists of four staves (right hand and left hand). The right hand plays a steady eighth-note accompaniment, while the left hand provides a harmonic foundation with chords and moving lines.

Musical score for piano accompaniment, measures 113-116. The piano part continues with the same accompaniment style as the previous system, maintaining the harmonic and rhythmic structure.

Vocal line with lyrics for measures 113-116. The lyrics are: "fi-nis, c' i - nis. fi - nis, fi - nis. ri - nis, fi - nis. e - rit fi - nis, fi - nis. s, cu - jus re - gni non e - rit fi - nis." The vocal line is written on a single staff with a treble clef and a key signature of one sharp (F#).

Musical score for piano accompaniment, measures 117-120. The piano part concludes the section with a final chord and a few concluding notes.

PROBEKOPPIERUNG
 Ausgabqualität gegenüber Original evtl. gemindert • Evaluation Copy - Quality may be reduced • Carus-Verlag

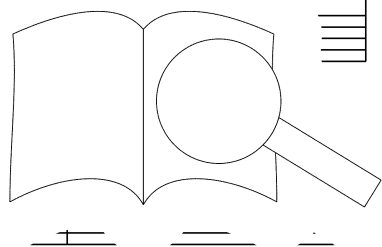

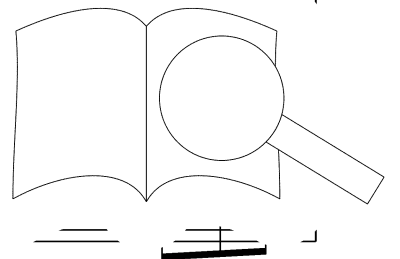

PROBEEPARTITUR
 Ausgabequalität gegenüber Original evtl. gemindert • Evaluation Copy - Quality may be reduced • Carus-Verlag

PROBENPAPIER
 Ausgabequalität gegenüber Original evtl. gemindert • Evaluation Copy - Quality may be reduced • Carus-Verlag

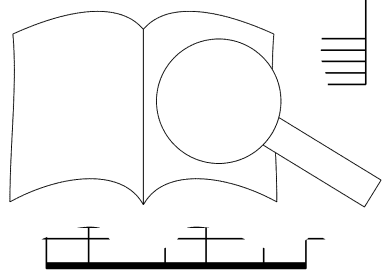

PROBEEPAARTEIL
 Ausgabequalität gegenüber Original evtl. gemindert • Evaluation Copy - Quality may be reduced • Carus-Verlag

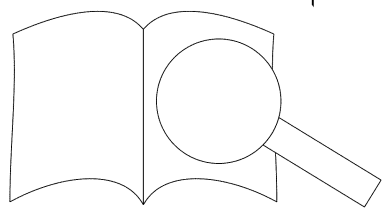

First system of musical notation, measures 1-4. It consists of three staves: a treble clef staff with a melodic line, a treble clef staff with a sustained chord and a tremolo (tr) marking, and a bass clef staff with a rhythmic accompaniment.

Second system of musical notation, measures 5-8. It consists of three staves: a treble clef staff with a melodic line, a treble clef staff with a sustained chord and a tremolo (tr) marking, and a bass clef staff with a rhythmic accompaniment.

Third system of musical notation, measures 9-12. It consists of three staves: a treble clef staff with a melodic line, a treble clef staff with a sustained chord and a tremolo (tr) marking, and a bass clef staff with a rhythmic accompaniment.

Fourth system of musical notation, measures 13-16. It consists of three staves: a treble clef staff with a melodic line, a treble clef staff with a sustained chord and a tremolo (tr) marking, and a bass clef staff with a rhythmic accompaniment.

Fifth system of musical notation, measures 17-20. It consists of three staves: a treble clef staff with a melodic line, a treble clef staff with a sustained chord and a tremolo (tr) marking, and a bass clef staff with a rhythmic accompaniment.

PROBENPAPIER
 Ausgabequalität gegenüber Original evtl. gemindert • Evaluation Copy - Quality may be reduced • Carus-Verlag

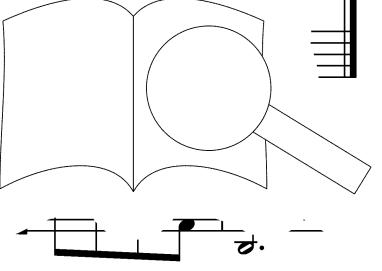

16. Et in Spiritum Sanctum

Oboe d'amore I

Oboe d'amore II

Basso

Continuo

6

12

tr

tr

San-ctum, Do - mi-num, et vi - vi - fi - can - - tem,

18

tr

tr

24

et in Spi-ri-tum San-ctum, Do - mi-num, et vi - vi - fi - can - tem,

30

can - tem, Spi-ri-tum San - ctum, Spi-ri-tum i - fi - i - fi - can - tem Do - mi-

36

num: qui - - que pro-ce - -

42

- - dit, ex Pa - tre Fi - li - o-que pro - ce - dit, qui ex Pa

48

- que pro-ce - dit.

54

60

- tre et Fi - li - o si-mul ad - o - ra - tur, ad - o -

66

- tur, et ci

72

- - - tur, et con - glo - ri - fi - ca - tur:

78

qui - lo - cu - tus est per Pro - ; lo - Pro - phe - tas, per Pro -

84

phe - tas lo - cu - tus est per Pro - phe - - tas, lo - cu - tus est per Pro -

90

phe - tas, per Pro - phe - tas. Et u - nam san - ctam

* Siehe / See "Individual Remarks"

96

cam Ec-cle - - - si-am,

102

ta - - - cam et a-po-sto - li -

108

cam Ec-cle - si ca-tho - - -

114

li - cam et a - po - sto-li - cam Ec - cle -

* Siehe / See "Individual Remarks"

PROBENPAPIER

Ausgabequalität gegenüber Original evtl. gemindert • Evaluation Copy - Quality may be reduced • Carus-Verlag

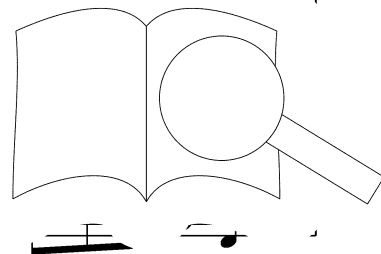

120

si - am, u - - - nam san - ctam ca-tho-li-cam et a-po-sto - li - cam

126

si - am, u - nam san - ctam ca - tho-li-cam et a - li - cam Ec-cle - si -

132

am.

PROBENPAPIER
Ausgabequalität gegenüber Original evtl. gemindert • Evaluation Copy - Quality may be reduced • Carus-Verlag

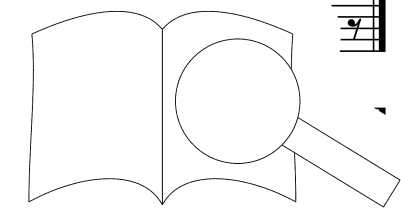

17a. Confiteor

Soprano I
Soprano II
Alto
Tenore
Basso
Continuo

Con - fi - te - or, con - fi - te - or u - num ba - ptis -
Con - fi - te - or, con - fi - te - or u - num ba -
Con - fi - te - or, con - fi -
Con - fi -
Continuo

8
ma, u - num ba - ptis - ma, u - ma, u - num ba - ptis -
ptis - ma, con - fi - te - or u - num ba - ptis -
or u - num ba - ptis - u - num ba - ptis -
- te - or u - num ba - ba - ptis - ma, u - num ba - ptis -
fi - te - or, con - fi - ptis - ma, u - num ba - ptis -

16
ma in re - mis - si - o -
in re - mis - si - o - nem pec - ca - to -
in re - mis - si - o - nem pec - ca - to - rum
re - mis - si - o - nem pec - ca - to - rum, in re - mis - si - o - nem
ma

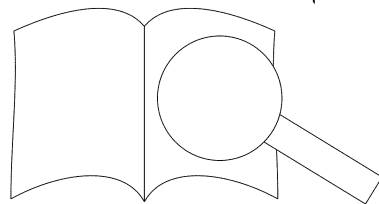

24

* nem pec-ca - to - rum, in re - mis - si - o - nem pec - ca - to - - rum, con -
 rum, in re - mis - si - o - nem pec - ca - to - - - - - rum, in re -
 pec - ca - to - rum, in re - mis - si - o - nem pec - ca - to - - rum, pec -
 rum, in re - mis - si - o - - nem pec - ca - to - - - - r
 in re - mis - si - o - - nem pec - ca - to - - - rum, in re - mis - si - o - nem

32

fi - te - or, con - fi - te - or u - num ba - - - - - nis - - - - - nem pec - ca -
 mis - si - o - - nem pec - ca - to - - rum, - - - - - te - or, con - fi -
 rum, in re - mis - si - o - - - - - rum, con - fi - te - or u - num ba -
 rum, con - te - or u - num ba - ptis - ma, u -
 rum,

40

to pec - ca - to - rum, in re - mis - si - o - - nem pec - ca -
 ptis - ma, con - fi - te - or u - num ba - ptis - ma, con - fi - te -
 - num ba - ptis - ma in re - mis - si - o - nem pec - ca - to - rum, con - fi - te - or u - num ba -
 is - ma, con - fi - te - or, con - fi - te - or u
 con - fi - te - or, con - fi - - te - or u - num ba

* Siehe / See "Individual Remarks"

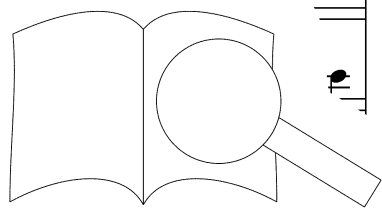

48

to - rum, con - fi - te - or, con - fi - te - or, con - fi - te - or u -
 or u - num ba - ptis - ma, con - fi - te - or, con - fi - te - or u - num ba - ptis - ma, con -
 ptis - ma in re - mis - si - o - nem pec - ca - to - rum, pec - ca - to - rum, con - fi
 con - fi - te - or, con - fi - te - or u - num ba - ptis
 mis - si - o - nem pec - ca - to - rum, in re - mis - si - o - nem pec - ca

56

- num ba - ptis - ma, con - fi - te - or, con - fi - te - or, con - fi - te - or u - num ba - ptis - ma in re -
 fi - te - or, con - fi - te - or, con - fi - te - or, con - fi - te - or u - num ba - ptis - ma
 or, con - fi - te - or in re - mis - si - o - nem pec - ca - to - rum, in re - mis - si -
 con - fi - te - or u - num ba - ptis - ma in re -
 con - fi - te - or u - num ba - ptis - ma in re - mis - si - o -

64

mis - si - o - nem pec - ca - to - rum, in re - mis - si - o - nem pec - ca -
 - nem pec - ca - to - rum, pec - ca - to - rum, in re - mis - si - o - nem
 - nem pec - ca - to - rum, pec - ca - to - rum, in re - mis - si - o -
 o - nem pec - ca - to - rum, pec - ca - to - rum, in
 - nem pec - ca - to - rum,

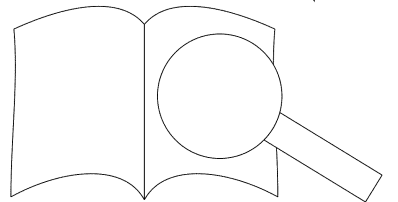

72

to - - - rum, in re - mis - si - o - - nem pec - ca - to - - - rum, pec - ca - to - rum, pec - ca - to -

pec - ca - to - rum, con - fi - te - or u - num ba - ptis - ma, con - fi - te -

- ca - to - rum, con - fi - te - or u - num ba - ptis -

to - - - rum, in re - mis - si - o - - nem pec - ca - to - rum

con - fi - te - or u - num ba -

80

rum, con - fi - te - or, con - fi - - ba - ptis - ma

or u - num ba - ptis - ma, con - fi - te - or, con - - num ba - ptis -

ma in re - mis - si - o - - nem pec - ca - to - -

re - mis - si - o - - nem pec - ca - to - -

in re - - - pec - ca - to - - - rum,

88

ir pec - ca - to - rum, in re - mis - si - o - - nem pec - ca -

- or in re - mis - si - o - - nem pec - ca - to - rum, con -

- te - or u - num ba - ptis - ma in re - mis - si - o - - nem pec - ca - to - rum,

con - - -

in re - mis - si - o - - nem pec - ca - to - rum,

PROBEKOPPIE
 Ausgabequalität gegenüber Original evtl. gemindert • Evaluation Copy - Quality may be reduced • Carus-Verlag

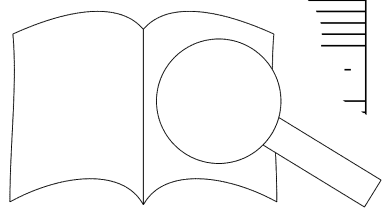

96

to - - - rum, con - fi - te - or, con-fi - te - or in re -
 fi - te - or, con - fi - te - or u - num ba - ptis - ma, con - fi - te - or, con-fi -
 con - fi - te - or, con - fi - te - or in re - mis - si - o - nem pec - ca - to -
 or u - num ba - ptis - ma
 in re - mis - si - o - nem pec - ca - to - rum, con - fi

105

mis - si - o - nem pec - ca - to - rum, in re - mis - si - o - nem pec - ca - to - rum,
 in re - mis - si - o - nem pec - ca - to - rum, u -
 in re - mis - si - o - nem pec - ca - to - rum, u -
 in re - mis - si - o - nem pec - ca - to - rum, u -

113

num ba - ptis - ma in re - mis - si - o - nem pec - ca -
 tis - ma in re - mis - si - o - nem pec - ca -
 in re - mis - si - o - nem pec - ca - to - rum, in re - mis - si - o - nem
 pec - ca - to - rum, in re -
 a, con - fi - te - or u - num ba - ptis - ma in re - mis - si - o -

121

Adagio *

17b. Et expecto

130

138

* Siehe / See "Individual Remarks"

146

Vivace e Allegro*

Tromba I
in Re / D

Tromba II
in Re / D

Tromba III
in Re / D

Timpani
in Re-La / d-A

Flauto traverso I

Flauto traverso II

Oboe I

Oboe II

Violino I

Violino II

Viola

Soprano I

Soprano II

Alto

Tenore

Continuo

The musical score consists of several staves. The top three staves are for Tromba I, II, and III, all in the key of D major. The Timpani part is in the bass clef. The woodwind section includes Flauto traverso I and II, Oboe I, and Oboe II. The string section includes Violino I and II, and Viola. The vocal section includes Soprano I and II, Alto, and Tenore. The Continuo part is in the bass clef. The lyrics are written below the vocal staves.

Original evtl. gemindert • Evaluation Copy - Quality may be reduced • Carus-Verlag

rum, et ex - pe - - cto, ex - pe - cto re-sur - re - cti -

cto, ex - pe - - cto re-sur-re - cti - o -

et ex - pe - - cto, ex - pe-cto re-sur - re - cti -

et ex - pe - - cto, ex - pe - - - cto re-sur - re - cti -

rum, et ex - pe - - cto, ex - pe-cto re-sur -

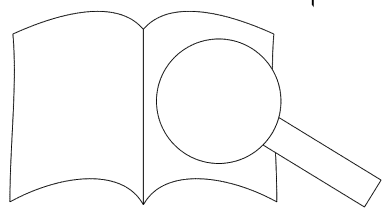

* Siehe / See "Individual Remarks"

o-nem mor-ti

am.

o - rum.

o - - rum.

em mor-tu - o - - rum.

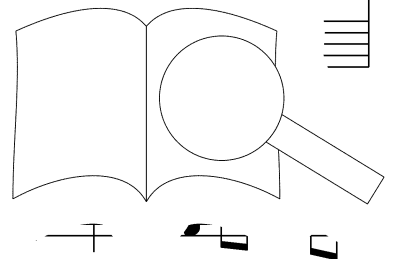

PROBENPAPIER
 Ausgabequalität gegenüber Original evtl. gemindert • Evaluation Copy - Quality may be reduced • Carus-Verlag

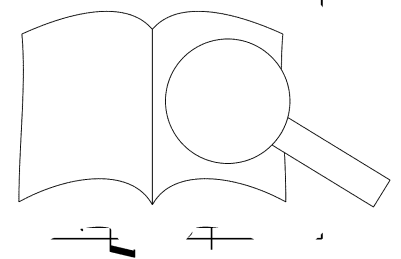

PROBENPAPIER
 Ausgabequalität gegenüber Original evtl. gemindert • Evaluation Copy - Quality may be reduced • Carus-Verlag

pe - - - - - o - - - - - nem mor - tu - o - - - - -

to, sur-re-cti - o - - - - - nem mor - tu - o - - - - -

nem mor - tu - o - - - - - rum, re-sur - re - cti -

nem mor-tu - o - - - - - rum, re-sur - re - cti - o - - - - - or-tu -

- - cto re-sur - re - cti - o - - - - - nem mor-tu - o

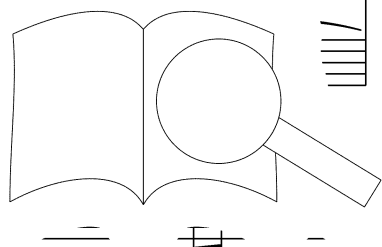

Musical notation for the first system, featuring vocal staves and piano accompaniment.

Musical notation for the second system, featuring vocal staves and piano accompaniment.

Musical notation for the third system, featuring vocal staves and piano accompaniment.

Musical notation for the fourth system, featuring vocal staves and piano accompaniment.

Musical notation for the fifth system, featuring vocal staves and piano accompaniment.

rum, - nem mor-tu - o - rum, et ex - pe - cto, ex -
 re-sur-re - cti - o - - - - - nem, et ex - pe -
 - - - - - rum, et ex - pe - cto, ex - pe - cto, ex -
 - - - - - rum, et ex - pe -
 - - - - - rum,

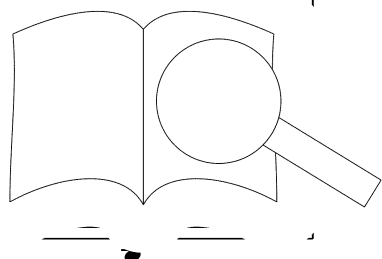

PROBENPAPIER
 Ausgabqualität gegenüber Original evtl. gemindert • Evaluation Copy - Quality may be reduced • Carus-Verlag

First system of musical notation, featuring three vocal staves (Soprano, Alto, Tenor) and a piano accompaniment staff. The music is in a major key with a 4/4 time signature.

Second system of musical notation, continuing the vocal and piano parts from the first system.

Third system of musical notation, continuing the vocal and piano parts.

Fourth system of musical notation, featuring lyrics under the vocal staves and piano accompaniment. The lyrics are: pe - cto, e . . . i - o-nem mor-tu - o - - rum, re - sur - sur - re-cti - o-nem mor-tu - o - - rum, .e-sur - re - cti - o - nem, re - sur - re-cti-o - - - cto re-sur - re - cti - o-nem mor-tu - o - - rum, ex - pe - cto re - sur - re-cti - o - nem mor-tu - o - - rum

PROBENFÜR

Ausgabequalität gegenüber Original evtl. gemindert • Evaluation Copy - Quality may be reduced • Carus-Verlag

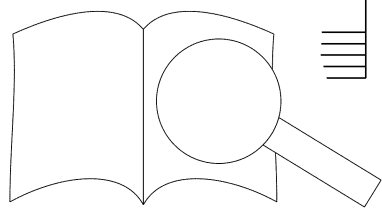

re - cti - o - - mor - tu - o - - - rum, re-sur - re - -
 re-sur - re-cti - o - - - - - nem, re-sur -
 - o - - - rum, re-sur - re-cti - o-nem mor - tu - o - -
 re-sur - re-cti - o - - - - - nem mor -

re-sur-re-cti - o - -

PROBEPARTITUR
 Ausgabequalität gegenüber Original evtl. gemindert • Evaluation Copy - Quality may be reduced • Carus-Verlag

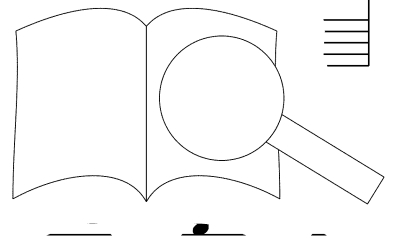

PROBENPARTITUR
Ausgabequalität gegenüber Original evtl. gemindert • Evaluation Copy - Quality may be reduced • Carus-Verlag

Musical score for three voices and bass, measures 203-207. The top three staves are for voices, and the bottom staff is for bass. The music features various note values and rests.

Musical score for piano, measures 203-207. The score is written for four staves (two treble and two bass clefs). It includes a key signature of one sharp (F#) and a time signature of 4/4.

Musical score for piano, measures 208-212. The score is written for four staves (two treble and two bass clefs). It includes a key signature of one sharp (F#) and a time signature of 4/4.

Musical score for piano and vocal, measures 213-217. The piano part is on the left (four staves) and the vocal part is on the right (two staves). The vocal line includes the lyrics "Et vi - - - tam ven -".

Musical score for bass, measures 213-217. The score is written on a single bass clef staff.

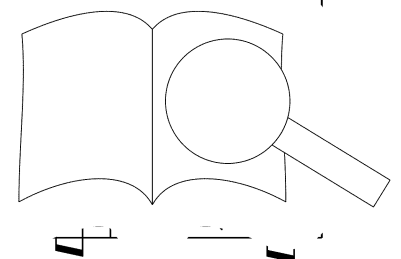

PROBENPAPIER
 Ausgabequalität gegenüber Original evtl. gemindert • Evaluation Copy - Quality may be reduced • Carus-Verlag

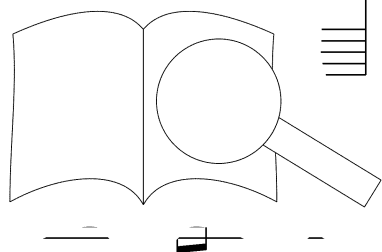

PROBEPARTITUR
Ausgabequalität gegenüber Original evtl. gemindert • Evaluation Copy - Quality may be reduced • Carus-Verlag

Musical notation system with three staves (treble clef).

Musical notation system with one staff (bass clef).

Musical notation system with four staves (treble clef).

Musical notation system with four staves (treble clef).

Vocal line with lyrics:
li, - - - cu-li, a - - - men, a -
sae - - - men,
- - - men, a - -
, ven - tu - ri sae - - - cu-li, a - -
- - - cu - li, ven - tu - ri sae - - -

Musical notation system with one staff (bass clef).



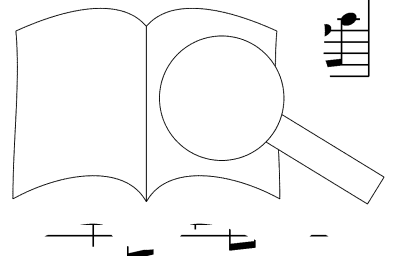

PROBENUR
Ausgabequalität gegenüber Original evtl. gemindert • Evaluation Copy - Quality may be reduced • Carus-Verlag

First system of musical notation, featuring vocal lines and piano accompaniment.

Second system of musical notation, featuring vocal lines and piano accompaniment.

Third system of musical notation, featuring vocal lines and piano accompaniment.

Fourth system of musical notation, featuring vocal lines and piano accompaniment.

Fifth system of musical notation, featuring vocal lines and piano accompaniment.

li, ven - a -
 li, a -
 a - men, a - - - - men,
 sae-cu-li, a - men, a - - - - men,
 ven - tu - ri sae-cu-li, a - men,

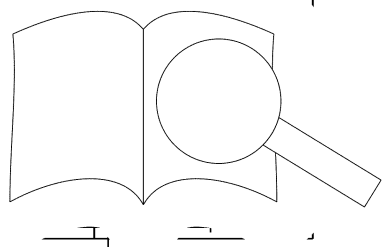

PROBENPAPIER
 Ausgabequalität gegenüber Original evtl. gemindert • Evaluation Copy - Quality may be reduced • Carus-Verlag

First system of musical notation, featuring vocal staves and piano accompaniment.

Second system of musical notation, featuring vocal staves and piano accompaniment.

Third system of musical notation, featuring vocal staves and piano accompaniment.

Fourth system of musical notation, featuring vocal staves with lyrics and piano accompaniment.

men, a - - men, a-men, a - - men,
 a - - men, a - - men, a - -
 - men, a - - men, a - -
 - men, a - -

Fifth system of musical notation, featuring vocal staves and piano accompaniment.

a - -

PROBEKOPPIERT
 Ausgabequalität gegenüber Original evtl. gemindert • Evaluation Copy - Quality may be reduced • Carus-Verlag

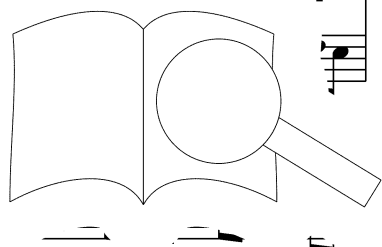

Musical score for three voices (Soprano, Alto, Tenor) and bass, measures 245-250. The score is in G major and 4/4 time. The Soprano part features a melodic line with a long note at the beginning. The Alto and Tenor parts have similar rhythmic patterns. The Bass part provides a steady accompaniment.

Musical score for piano accompaniment, measures 245-250. The piano part consists of a right-hand melody and a left-hand accompaniment. The right hand has a flowing eighth-note pattern, while the left hand has a more rhythmic accompaniment.

Musical score for piano accompaniment, measures 251-255. The piano part continues with the same melodic and rhythmic patterns as the previous system.

Musical score with lyrics for three voices and piano accompaniment, measures 256-260. The lyrics are: a - men, a - men, a - men, ven - tu - ri sae - cu - li, a - men. - men - tam ven - tu - ri sae - cu - li, ven - tu - ri sae - cu - li, a - men. pe - cto vi - tam ven - tu - ri sae - cu - li, a - men. pe - cto vi - tam ven - tu - ri sae - cu - li, a - men.

Musical score for piano accompaniment, measures 261-265. The piano part concludes the section with a final melodic flourish.

PROBEKOPPIE
 Ausgabequalität gegenüber Original evtl. gemindert • Evaluation Copy - Quality may be reduced • Carus-Verlag

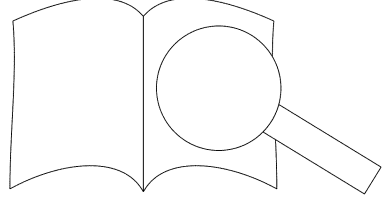

III. Sanctus

18a. Sanctus

Tromba I
in Re / D

Tromba II
in Re / D

Tromba III
in Re / D

Timpani
in Re-La / d-A

Oboe I

Oboe II

Oboe III

Violino I

Violino II

Viola

Soprano I
Sar - ctus, San - ctus, San - ctus, San - ctus,

Soprano II
- ctus, San - ctus, San - ctus, San - ctus,

Alto I
San - ctus, San - ctus, San - ctus, San - ctus,

Alto II
- ctus, San - ctus, San - ctus, San - ctus,

Alto III
San - ctus, San - ctus,

Alto IV
San - ctus, San - ctus,

Continuo

ctus,
 us Sa-ba-oth, San - ctus,
 o - mi-nus De - us Sa - ba - oth, San - ctus, San -

ctus Do - mi-nus De - us Sa - ba - oth, San
 San - ctus Do - mi-nus De - us Sa - ba - oth, Sa

PROBE PAPIER
 Ausgabqualität gegenüber Original evtl. gemindert • Evaluation Copy - Quality may be reduced • Carus-Verlag

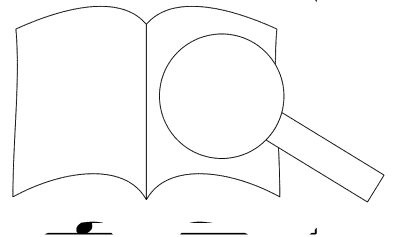

8

San - ctus, San - ctus, ctus, San - ctus Do - mi-nus, ctus, San - ctus Do - mi-nus, us, San - ctus, San - ctus, ctus, San - ctus.

PROBEPARTITUR
 Ausgabequalität gegenüber Original evtl. gemindert • Evaluation Copy - Quality may be reduced • Carus-Verlag

San - ctus, San - ctus, San -
 San - ctus, San - ctus, San -
 De ctus, San - ctus, San - ctus, San -
 San - ctus, San - ctus, San - ctus, San -
 - na - oth, San - ctus, San - ctus, San -
 us Sa - ba - oth, San - ctus, San - ctus,

PROBEPAPIER
 Ausgabequalität gegenüber Original evtl. gemindert • Evaluation Copy - Quality may be reduced • Carus-Verlag

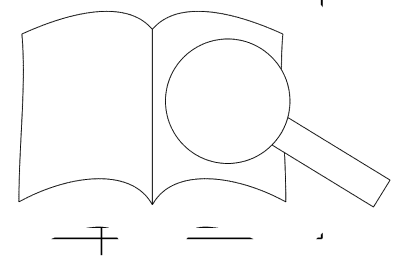

ctus, San - - -
 ctus, San - - -
 ctus, San - - -
 San - - - ctus, San - - -
 ctus, San - - - ctus, San - - -
 San - ctus Do - mi - nus De - us Sa - ba - oth, S

PROBE PAPIER

Ausgabequalität gegenüber Original evtl. gemindert • Evaluation Copy - Quality may be reduced • Carus-Verlag

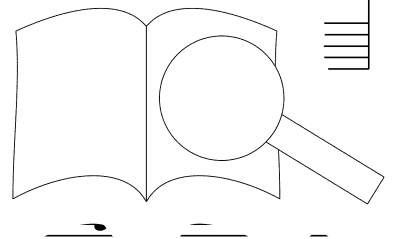

- - ctus, S. - ctus, San-ctus Do - mi-nus De -
 - - ctus, - - ctus, San - ctus Do - mi-nus
 - - ctus, San - ctus Do - mi-nus De -
 Jan - - ctus, San - -
 San - - ctus, San -

s Sa - ba-oth, San - ctus Do - mi-nus De - us Sa - ba-oth, San

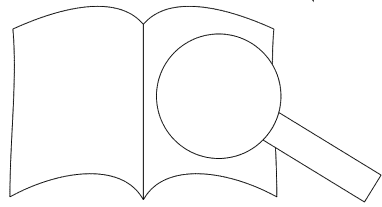

PROBEPAPIER
 Ausgabqualität gegenüber Original evtl. gemindert • Evaluation Copy - Quality may be reduced • Carus-Verlag

Empty musical staves for piano accompaniment, showing treble and bass clefs.

Musical notation for piano accompaniment, featuring treble and bass clefs with rhythmic patterns and a triplet of eighth notes.

Musical notation for piano accompaniment, featuring treble and bass clefs with rhythmic patterns and a triplet of eighth notes.

Vocal notation with lyrics: - us Sa - ba-oth, De - us, San - ctus, San - ctus, San - ctus, Sa - ba-oth, San - ctus, San - ctus, San - ctus, - us Sa - ba-oth, San - ctus, San - ctus, San - ctus.

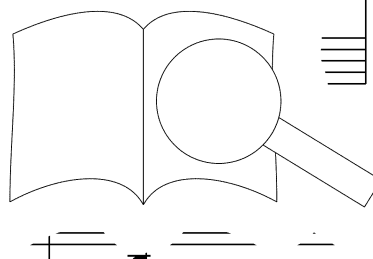

PROBEPARTI
Ausgabequalität gegenüber Original evtl. gemindert • Evaluation Copy - Quality may be reduced • Carus-Verlag

- ctus Do - mi-nu
 - ctu
 as Sa - ba-oth, San - ctus, San - ctus,
 as De - us Sa - ba-oth, San - ctus,
 o - mi-nus De - us Sa - ba-oth, San - ctus
 ctus Do - mi-nus De - us Sa - ba-oth,

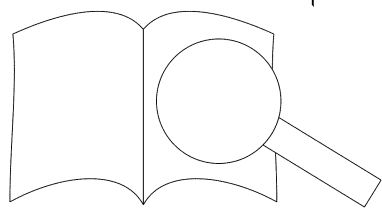

PROBEKOPPIE
 Original evtl. gemindert • Evaluation Copy - Quality may be reduced • Carus-Verlag

First system of musical notation, featuring three vocal staves (Soprano, Alto, Tenor) and a piano accompaniment staff. The piano part includes a bass line and a treble line with a 3-measure triplet.

Second system of musical notation, continuing the vocal and piano parts. The piano accompaniment features a prominent 3-measure triplet in the treble clef.

Third system of musical notation, showing further development of the vocal and piano parts. The piano accompaniment includes a 3-measure triplet in the bass clef.

Fourth system of musical notation, featuring vocal staves with lyrics and piano accompaniment. The lyrics are: "San - ctus Do - mi - nus De - us Sa - ba - oth, San - ctus, San - ctus Do - mi - nus De - us Sa - ba - oth, Sa". The piano accompaniment includes a 3-measure triplet.

PROBEKOPPIERT
 Original evtl. gemindert • Evaluation Copy - Quality may be reduced • Carus-Verlag

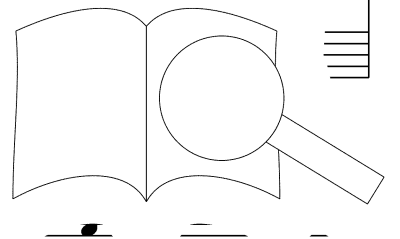

First system of musical notation, featuring vocal staves and piano accompaniment.

Piano accompaniment for the first system.

Second system of musical notation, featuring vocal staves and piano accompaniment.

Third system of musical notation, featuring vocal staves and piano accompaniment.

Fourth system of musical notation, featuring vocal staves and piano accompaniment.

Fifth system of musical notation, featuring vocal staves and piano accompaniment.

Sixth system of musical notation, featuring vocal staves and piano accompaniment.

PROBE PAPIER
 Ausgabqualität gegenüber Original evtl. gemindert • Evaluation Copy - Quality may be reduced • Carus-Verlag

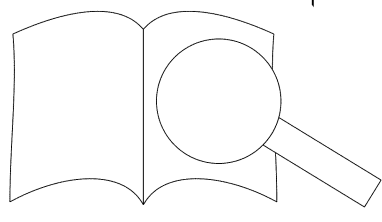

ctus, San - ctus, San - ctus, ctus, San - ctus, San - ctus, ctus, San - ctus, San - ctus, ctus, us Sa - ba-oth, San - ctus, San - ctus, ctus,

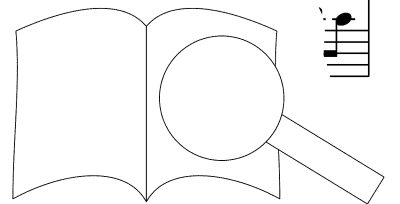

PROBEPARTITUR
 Ausgabqualität gegenüber Original evtl. gemindert • Evaluation Copy - Quality may be reduced • Carus-Verlag

18b. Pleni sunt coeli

48

Three staves of musical notation, each containing a whole rest for the duration of the measure.

One staff of musical notation containing a whole rest.

Three staves of musical notation. The top staff has a treble clef and a key signature of one sharp (F#). The middle and bottom staves have a bass clef and a key signature of one sharp. The top staff begins with a quarter note G4, followed by a quarter rest. The middle and bottom staves begin with a quarter note G4, followed by a quarter rest.

Three staves of musical notation. The top staff has a treble clef and a key signature of one sharp. The middle and bottom staves have a bass clef and a key signature of one sharp. The top staff begins with a quarter note G4, followed by a quarter rest. The middle and bottom staves begin with a quarter note G4, followed by a quarter rest.

Three staves of musical notation. The top staff has a treble clef and a key signature of one sharp. The middle and bottom staves have a bass clef and a key signature of one sharp. The top staff begins with a quarter note G4, followed by a quarter rest. The middle and bottom staves begin with a quarter note G4, followed by a quarter rest.

oth.

oth.

ot

Ple-ni sunt coe-li et

coe-li et ter-ra glo-ri-a e-

1.

One staff of musical notation with a bass clef and a key signature of one sharp. It begins with a quarter note G4, followed by a quarter rest, and then continues with a melodic line.

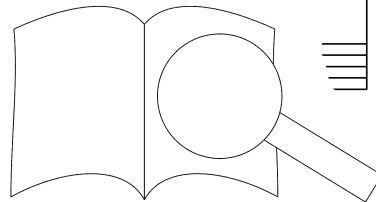

56

Ple - ni sunt coe - li et ter - ra glo - - -
 ter - ra glo - - - ri - a e - jus, glo - - -
 - - - ri - a e - jus, ple - cu

64

- ri - a e - i et ter - ra glo - - - ri - a -
 - coe - li et ter - ra glo - - - ri - a e -
 e - jus, glo - - - ri - a -
 - ra glo - - - ri - a e - jus

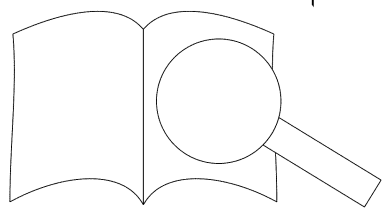

PROBEPARTITUR
 Ausgabequalität gegenüber Original evtl. gemindert • Evaluation Copy - Quality may be reduced • Carus-Verlag

PROBEKOPPIE
 Original evtl. gemindert • Evaluation Copy - Quality may be reduced • Carus-Verlag

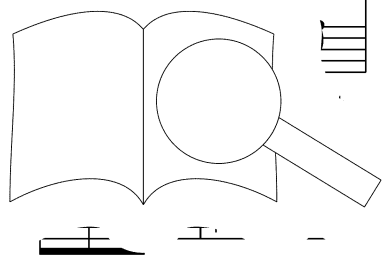

Original evtl. gemindert • Evaluation Copy - Quality may be reduced • Carus-Verlag

PROBEPARTITUR

Ausgabequalität gegenüber

e - jus, ple - ni sunt

- - a e - jus, ple - ni sunt

sunt coe - li glo - - - - ri - a

ple - ni sunt coe - li glo - - - - ri - a

ple - ni sunt coe - li,

et ter - - ra, ple - ni sunt coe - li et te

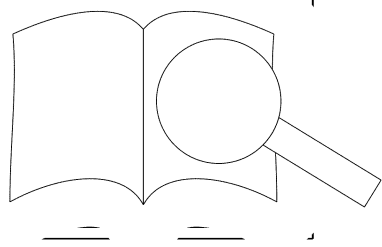

coe-li, sunt coe - ær - ri - a e - jus, ple - ni sunt coe -
 coe-li et - - ra glo-ri - a e - jus, ple - ni, ple - ni sunt
 e - - ri - a e - jus, ple - ni
 - ri - a, glo - ri - a e - jus, ple -
 ær-ra glo - ri - a e - jus,
 ple - ni sunt coe - li et ter - ra glo - ri - a e - jus,

* Siehe / See "Individual Remarks"

PROBENPAPIER

Ausgabequalität gegenüber Original evtl. gemindert • Evaluation Copy - Quality may be reduced • Carus-Verlag

- li et ter - ra, - li ter - ra glo - - ri - a e -
 coe - - li sunt coe - li et ter - ra glo - - ri - a e -
 glo a, ple - ni sunt coe - li et ter - ra glo - ri - a e - -
 - - - - - ri - a e - -
 glo - - - - -

PROBEPARTITUR

Ausgabequalität gegenüber Original evtl. gemindert • Evaluation Copy - Quality may be reduced • Carus-Verlag

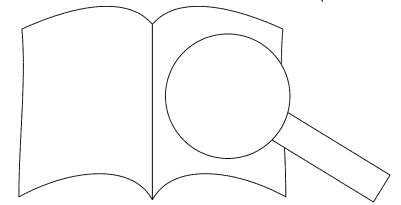

tr

tr

tr

tr

jus,

ple - ni sunt coe - li

glo -

jus,

jus

ant coe - li et ter -

ra, ple -

ni sunt coe - li et

ple - ni sunt coe - li

ple - ni

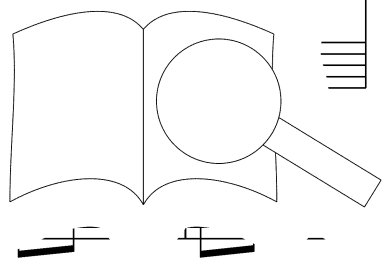

PROBEPARTITUR
 Ausgabegqualität gegenüber Original evtl. gemindert • Evaluation Copy - Quality may be reduced • Carus-Verlag

ri-a, ple - ni sun' - ra - - ri - a e - jus, glo -

- - - ri - a e - jus, ple - ni sunt

glo - - - ri - a e - jus,

glo - - - ri - a e - jus, ple - ni sunt

glo - - ri-a, glo - - ri -

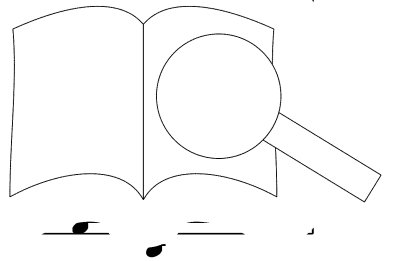

PROBE PAPIER
 Ausgabqualität gegenüber Original evtl. gemindert • Evaluation Copy - Quality may be reduced • Carus-Verlag

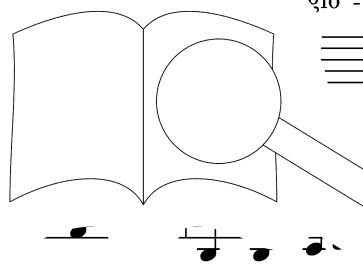

Musical notation for the first system, including vocal line and piano accompaniment.

Musical notation for the second system, including vocal line and piano accompaniment.

Musical notation for the third system, including vocal line and piano accompaniment.

Musical notation for the fourth system, including vocal line and piano accompaniment.

Musical notation for the fifth system, including vocal line and piano accompaniment.

PROBEKOPPIERUNG
 Ausgabqualität gegenüber Original evtl. gemindert • Evaluation Copy - Quality may be reduced • Carus-Verlag

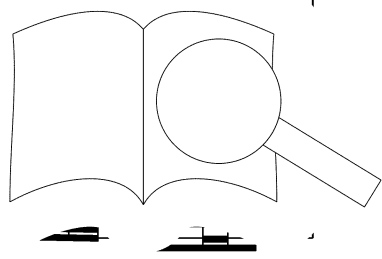

PROBE PAPIER
 Ausgabqualität gegenüber Original evtl. gemindert • Evaluation Copy - Quality may be reduced • Carus-Verlag

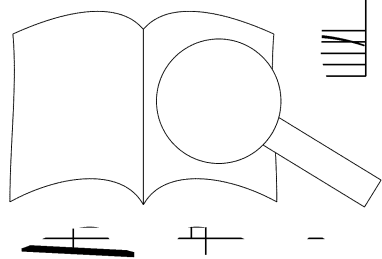

Musical notation for the first system, featuring a vocal line and piano accompaniment.

Musical notation for the second system, featuring a vocal line and piano accompaniment.

Musical notation for the third system, featuring a vocal line and piano accompaniment.

Musical notation for the fourth system, including lyrics:
 - - - ri - a ni æ - li et ter - ra glo - - - ri - a
 glo - - - s, ple - ni sunt coe - li et - ter - ra, et ter - ra glo - ri -
 e - jus, ple - ni sunt coe - li et ter - ra glo - ri - a
 - ri - a e - jus, ple - ni sunt coe - li et ter - ra glo - ri - a
 - ri - a e - jus, ple - ni sunt coe - li et ter

Musical notation for the fifth system, including lyrics:
 - a, glo - - - - -

PROBEPAPIER
 Ausgabqualität gegenüber Original evtl. gemindert • Evaluation Copy - Quality may be reduced • Carus-Verlag

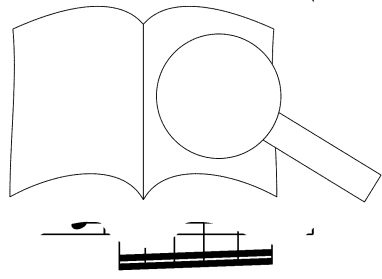

tr tr tr tr tr tr

e - jus, {

a e

ni sunt coe - li, ple - - ni sunt coe - li et ter - -

e - - ni sunt coe - li, ple - - ni sunt coe - li et ter - -

jus, ple - - ni sunt coe - li, ple - - ni sunt

e - jus, ple - - ni sunt coe - li et ter - ra glo - r



PROBE PAPIER

Ausgabequalität gegenüber Original evtl. gemindert • Evaluation Copy - Quality may be reduced • Carus-Verlag

First system of musical notation, featuring vocal lines and piano accompaniment.

Second system of musical notation, primarily piano accompaniment.

Third system of musical notation, primarily piano accompaniment.

Fourth system of musical notation, including vocal lines with lyrics:

- ri-a e - jus.

- ri-a e - jus.

, ple - ni sunt coe - li et ter - ra glo - ri - a e - - jus.

- ra, ple - ni sunt coe - li et ter - ra glo - ri - a e - jus.

- - ra, ple - ni sunt coe - li et ter - ra glo -

Fifth system of musical notation, including piano accompaniment and lyrics:

et ter - - ra, sunt coe - li et ter - ra glo - -

PROBENPAPIER
 Ausgabqualität gegenüber Original evtl. gemindert • Evaluation Copy - Quality may be reduced • Carus-Verlag

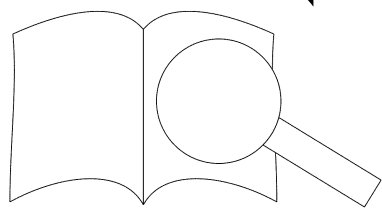

na, o - san - na, o - san - na in ex - cel - sis,
na, o - san - na, o - san - na in ex - cel - sis, o - san -
na, o - san - na, o - san - na in ex - cel - sis,
san - na, o - san - na in ex - cel - sis,
na, o - san - na, o - san - na in ex - cel - sis,
o - san - na, o - san - na in ex - cel - sis,
san - na, o - san - na, o - san - na in ex - cel - sis,
na, o - san - na, o - san - na in ex - cel - sis,
na, o - san - na, o - san - na in ex - cel - sis,

PROBENPAPIER
Ausgabequalität gegenüber Original evtl. gemindert • Evaluation Copy - Quality may be reduced • Carus-Verlag

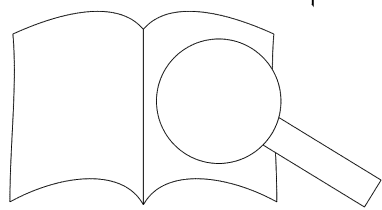

o - san - na in ex - cel - sis, o - san - na in ex - cel - sis, o - san - na in ex - cel - sis, o - san - na in ex - cel - sis, o - san - na in ex - cel - sis

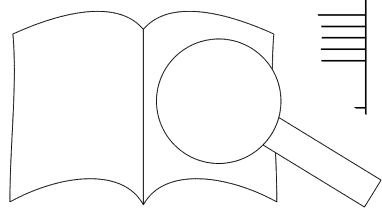

PROBENPAPIER
 Ausgabequalität gegenüber Original evtl. gemindert • Evaluation Copy - Quality may be reduced • Carus-Verlag

san - - - na in ex - cel - - - sis, o - - - na in ex - cel - - - sis, o - san - na, o - san - - - na, o - - - sis, o - san - na, o - san - - - na, o - - - in ex - cel - sis, o - san - na, o - san - - - na, o - - - sis, o - san - na, o - san - - -

o - san - na in ex - cel - sis, o - san - na in ex -
o - san - na in ex - cel - sis, o - san - na in ex -
o - san - na in ex - cel - sis, o - san - na in ex -

o - san - na in ex - cel - sis,

PROBEPAPIER
Ausgabequalität gegenüber Original evtl. gemindert • Evaluation Copy - Quality may be reduced • Carus-Verlag

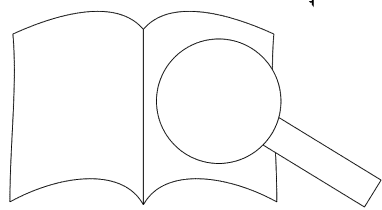

san - na in ex - cel - sis, o - san - na, o - san - na in ex - cel - sis,

san - na in - sis, o - san - na, o - san - na in ex - cel - sis,

san - sis, o - san - na, o - san - na in ex - cel - sis,

- sis, o - san - na, o - san - na in ex -

o - san-na in ex - cel-sis,

o - san-na in ex - cel-sis,

o - san-na in ex - cel-sis,

cel-sis, o - san-na in ex - cel-sis,

PROBEKOPPIE
 Ausgabqualität gegenüber Original evtl. gemindert • Evaluation Copy - Quality may be reduced • Carus-Verlag

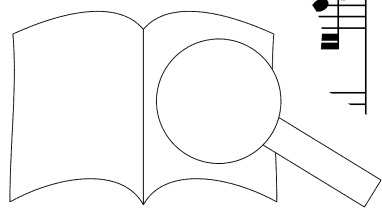

- na, o - san - na in ex - cel - sis,
 - na, o - san - na in ex -
 - sis, o - san - r
 cel - sis, r

o - san

na in ex - cel - sis, o -

na in ex - cel - sis, o - san

o - san

PROBENPAPIER
 Ausgabqualität gegenüber Original evtl. gemindert • Evaluation Copy - Quality may be reduced • Carus-Verlag

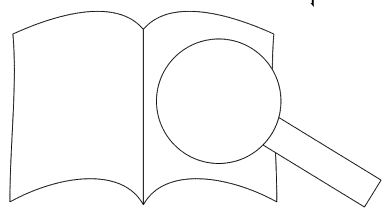

Musical notation for the first system, including vocal staves and piano accompaniment.

Musical notation for the second system, including vocal staves and piano accompaniment.

Musical notation for the third system, including vocal staves and piano accompaniment.

Musical notation for the fourth system, including vocal staves and piano accompaniment.

Musical notation for the fifth system, including vocal staves and piano accompaniment.

Musical notation for the sixth system, including vocal staves and piano accompaniment.

Musical notation for the seventh system, including vocal staves and piano accompaniment.

PROBEPAPIER
 Ausgabegqualität gegenüber Original evtl. gemindert • Evaluation Copy - Quality may be reduced • Carus-Verlag

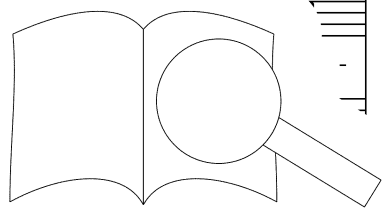

cel - sis, o -

cel - sis, an - r san - na,

cel - sis, a, o - san - na,

cel - sis, o - san - na, o - san - na, o - san -

cel - sis, o - san - na in ex - cel - sis, o -

ex - cel - sis, o - san - na in ex - cel - sis, o -

sar - na in ex - cel - sis, o - san - na, o - san - na in ex -

- na in ex - cel - sis, o - san - na in ex -

PROBENPAKUNGSUR
Ausgabequalität gegenüber Original evtl. gemindert • Evaluation Copy - Quality may be reduced • Carus-Verlag

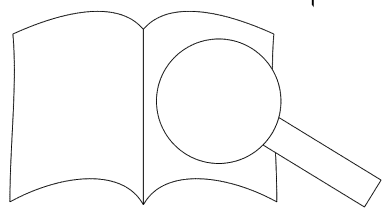

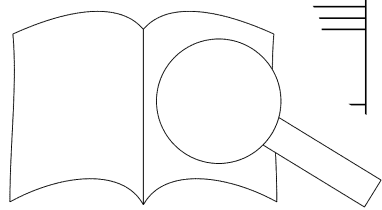

na, o - - - - - o - san-na in ex - cel - sis,

- na, o - san-na in ex - cel - sis, o - san-na in ex - cel - sis,

cel - sis, o - san-na in ex - cel - sis,

san-na in o - san-na in ex - cel - sis,

o - san-na in ex - cel - sis,

na in ex - cel - sis, o - san - na, o - san-na in ex -

o - san - - - - - na, o - san-na in ex -

o - san - - - - -

PROBENPAPIER
 Ausgabequalität gegenüber Original evtl. gemindert • Evaluation Copy - Quality may be reduced • Carus-Verlag

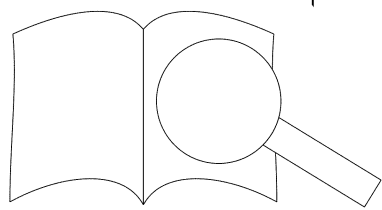

First system of musical notation, featuring vocal staves and piano accompaniment.

Second system of musical notation, featuring vocal staves and piano accompaniment.

Third system of musical notation, featuring vocal staves and piano accompaniment.

Fourth system of musical notation, featuring vocal staves and piano accompaniment.

Fifth system of musical notation, featuring vocal staves and piano accompaniment.

Sixth system of musical notation, featuring vocal staves and piano accompaniment.

PROBEKOPPIERUNG
 Ausgabegqualität gegenüber Original evtl. gemindert • Evaluation Copy - Quality may be reduced • Carus-Verlag

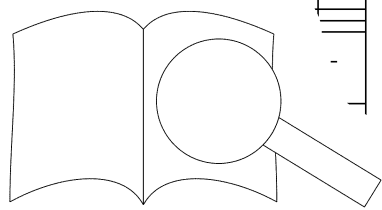

tr

tr

- na, o - san - na in ex - cel - sis, o - san - na in ex -

- na, o - san - na in ex - cel - sis, o - san - na in ex -

- na, o - san - na in ex - cel - sis, o - san - na in ex -

- na, o - san - na in ex - cel - sis, o - san - na in ex -

o - san - na in ex - cel - sis, o - san - na in ex -

o - san - na in ex - cel - sis, o - san - na, o - san - na,

o - san - na in ex - cel - sis, o - san - na, o - san - na,

o - san - na in ex - cel - sis, o - san - na, o - san - na,

na, o - san - na in ex - cel - sis, o - san - na in ex -
 na, o - san - na in ex - cel - sis, o - san - na in ex -
 na, o - san - na in ex - cel - sis, o - san - na in ex -
 na, o - san - na in ex - cel - sis, o - san - na in ex -
 o - san - na in ex - cel - sis, o - san - na in ex -
 o - san - na in ex - cel - sis, o - san - na, o - san - na,
 o - san - na in ex - cel - sis, o - san - na, o - san - na,
 o - san - na in ex - cel - sis, o - san - na, o - san - na,

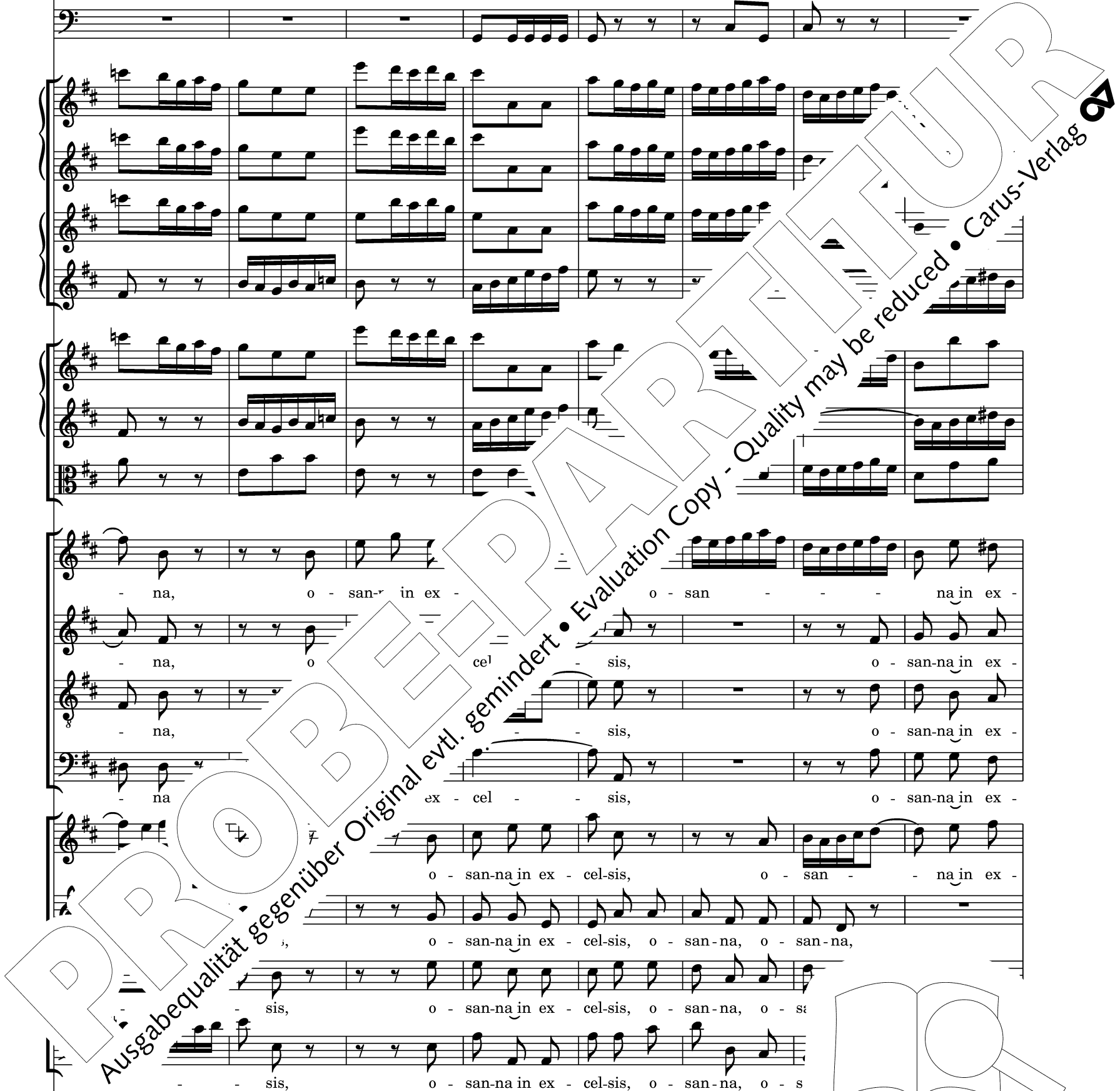

cel - sis, o - san - - - - - cel - sis, o - san-na in ex - cel - sis, o -

cel - sis, - - - - - in - - - - - sis, o - san-na, o - san-na in ex - cel - sis, o -

cel - sis, - - - - - ex - cel - sis, o - san-na, o - san-na in ex - cel - sis, o -

cel - sis, - - - - - san-na in ex - cel - sis, o - san-na, o - san-na in ex - cel - sis,

san - - - - - na in ex - cel - sis, o - san-na, o - san-na in ex - cel - sis,

o - san-na, o - san-na, o - san-na in ex - cel - sis,

- san - na, o - san-na, o - san-na,

o - san - na, o - san-na, o - san-na,

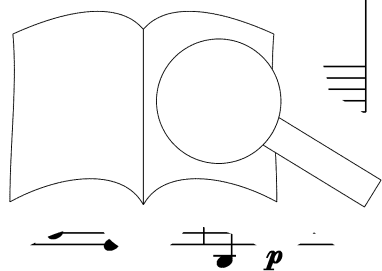

* Siehe / See "Individual Remarks"

tr.

Musical notation for the first system, including vocal line and piano accompaniment.

Musical notation for the second system, including vocal line and piano accompaniment.

Musical notation for the third system, including vocal line and piano accompaniment.

Musical notation for the fourth system, including vocal line and piano accompaniment.

Musical notation for the fifth system, including vocal line and piano accompaniment.

Musical notation for the sixth system, including vocal line and piano accompaniment.

san - na in ex - cel - sis, - - - - - na, o - san - na, o -
 san - na in ex - - - - - na, o - san - na, o -
 san - - - - - o - san - - - - - na, o - san - na, o - san - na, o -
 o - san - na in ex - cel - sis, o - san - - - - - na, o -
 in ex - cel - sis, o - san - - - - - na, o - san - - - - - na,
 in ex - cel - - - - sis, o - san - - - - na, o - san - na,
 o - san - - - - na, o - san - - - -
 o - san - na in ex - cel - sis, o -

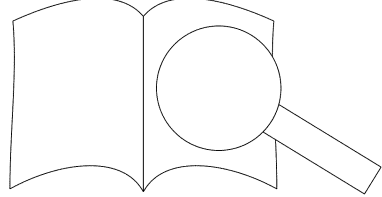

Musical notation for the first system, featuring vocal lines and piano accompaniment.

Musical notation for the second system, featuring vocal lines and piano accompaniment.

Musical notation for the third system, featuring vocal lines and piano accompaniment.

Musical notation for the fourth system, featuring vocal lines and piano accompaniment.

Musical notation for the fifth system, featuring vocal lines and piano accompaniment.

Musical notation for the sixth system, featuring vocal lines and piano accompaniment.

PROBEKOPPIERT
 Ausgabqualität gegenüber Original evtl. gemindert • Evaluation Copy - Quality may be reduced • Carus-Verlag

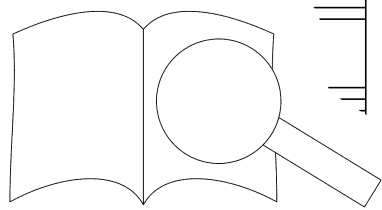

The first system of music features three staves. The top two staves are vocal lines with treble clefs, containing melodic lines with various note values and rests. The bottom staff is a piano accompaniment line with a bass clef, providing harmonic support. The system concludes with a trill (tr) marking over a note in the vocal line.

A single bass clef staff showing the piano accompaniment for the first system, with rhythmic patterns and chordal structures.

The second system continues the musical piece with three staves. It features vocal lines and piano accompaniment, maintaining the melodic and harmonic themes established in the first system.

The third system of music, consisting of three staves, further develops the vocal and piano parts. The piano accompaniment includes more complex rhythmic figures.

The fourth system shows the continuation of the musical score. The vocal lines and piano accompaniment are clearly visible across the three staves.

The fifth system of music, with three staves, continues the piece. The piano accompaniment features a steady rhythmic pattern.

A single bass clef staff showing the piano accompaniment for the fifth system, which includes a trill (tr) marking.

PROBEKOPPIE
 Ausgabequalität gegenüber Original evtl. gemindert • Evaluation Copy - Quality may be reduced • Carus-Verlag

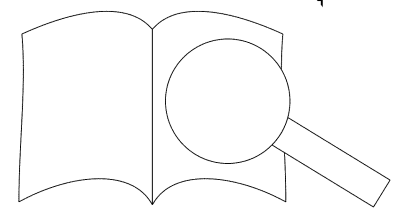

Musical notation for the first system, featuring vocal lines with trills (tr) and piano accompaniment.

Bass line musical notation for the first system.

Piano accompaniment musical notation for the second system.

Piano accompaniment musical notation for the third system.

Empty musical staves for the fourth system.

Empty musical staves for the fifth system.

Bass line musical notation for the sixth system.

PROBEPARTITUR
 Ausgabequalität gegenüber Original evtl. gemindert • Evaluation Copy - Quality may be reduced • Carus-Verlag

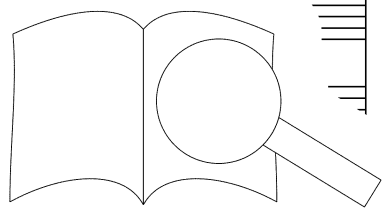

The image displays a musical score for piano and voice. It consists of several systems of staves. The top system features three vocal staves (soprano, alto, and tenor) and a piano accompaniment staff. The piano part is written in a grand staff (treble and bass clefs) with a key signature of one sharp (F#). The score includes various musical notations such as notes, rests, and dynamic markings. A large, diagonal watermark reading 'PROBEPARTITUR' is overlaid across the entire page. Below the watermark, there is a line of text: 'Ausgabequalität gegenüber Original evtl. gemindert • Evaluation Copy - Quality may be reduced • Carus-Verlag'. At the bottom right of the page, there is a small icon of an open book with a magnifying glass over it.

20. Benedictus

Flauto traverso*
 Tenore
 Continuo

10
 Tenore

13
 di

o - mi - ni, qui ve - nit, be - ne - di -

* Zur Besetzung mit Flauto traverso siehe die „Hinweise zur Notation und Aufführungspraxis“.
 Concerning scoring with Flauto traverso, see the "Issues of notation and performance practice."

19

ve - nit in no - mi - ne Do - mi - ni, in no - - mi - ne Do - mi - ni, be - ne -

23

di - ctus, be - ne - di - - ctus qui ve - ni^t .ni

26

ni.

29

Be -

32

ctus, be - ne - di - ctus qui ve - nit in no - mi - ne

Do - mi - ni, be - ne - di - - ctus, be - ne - di -

38

8 - nit in no - mi - ne Do - mi - ni, qui ve - nit in no - mi - ne Do - mi -

41

8 ni, be - ne - di - ctus, be - ne - di qui

44

8 ve - nit in no - mi - ne Do - mi - ni, qui nit, qui ve - nit in

47

8 no - - r-

51

3 3

21. Osanna repetatur

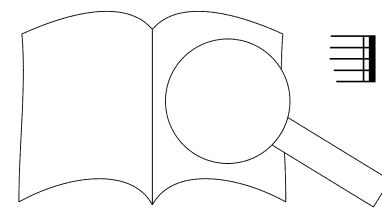
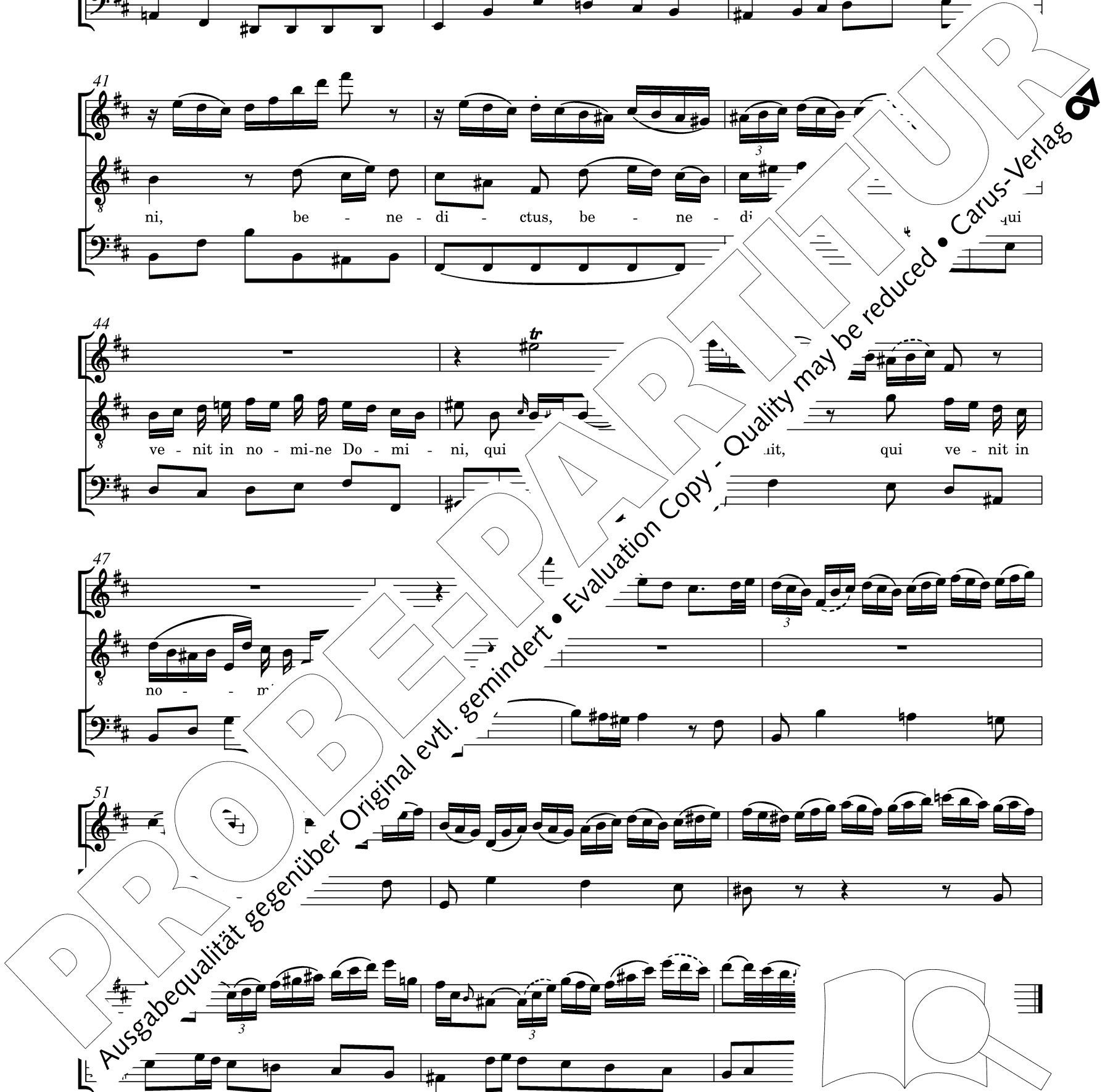

22. Agnus Dei

Violino I, II

Alto

Continuo

5

9

Alto

A - gnus De - - i, qui tol - - mun -

13

di, qui tol-lis pec - ca -

mun-di: mi - se - re - - re - no -

17

- re - no - bis, mi - se - re - re - no - bis, qui tol - lis pec -

ca - ta, pec - ca - ta - mun-di: mi-se-re-re no - bis.

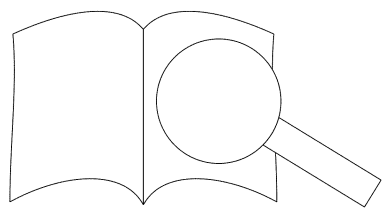

25

A - gnus De - - i, qui tol - -

29

- lis pec - ca - - ta - - mun - di, A - gnus De - -

33

- lis pec - ca - - ta, qui tol - lis pec - ca - - an - di, qui tol - lis pec -

37

ca - ta: mi - se - ca - ta: mi - se - re - re - no - bis, mi - se - re -

41

mi - se - re - re no - bis, mi - se - re - re no - bis, mi - se - re - re - no -

bis.

bis.

23. Dona nobis pacem

Tromba I
in Re / D

Tromba II
in Re / D

Tromba III
in Re / D

Timpani
in Re-La / d-A

Flauto traverso I, II
Oboe I

Oboe II

Fagotto I, II *

Violino I

Violino II

Viola

Soprano I, II

Alto I, II

Continuo

Do - na no - bis pa - cem, pa -

Do - na no - bis pa - cem, pa - cem,

Do - na no - bis pa - cem, pa - cem,

Do - na no - bis pa - cem, pa - cem,

Do - na no - bis pa - cem, pa - cem,

* Zur Mitwirkung der Fagotte siehe die „Hinweise der Notation und Aufführungspraxis“.
Concerning the participation of the bassoons, see the "Issues of notation and performance practice."

6

cem, pa - - - cem do - - -

pa - - - cem do - - - na no -

do - - - na no - bis,

- - - na no - bis,

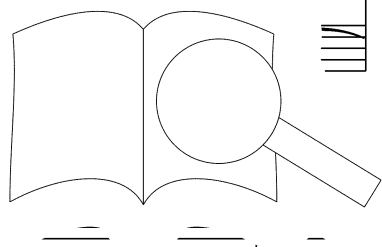

PROBEPARTITUR
 Ausgabequalität gegenüber Original evtl. gemindert • Evaluation Copy - Quality may be reduced • Carus-Verlag

9

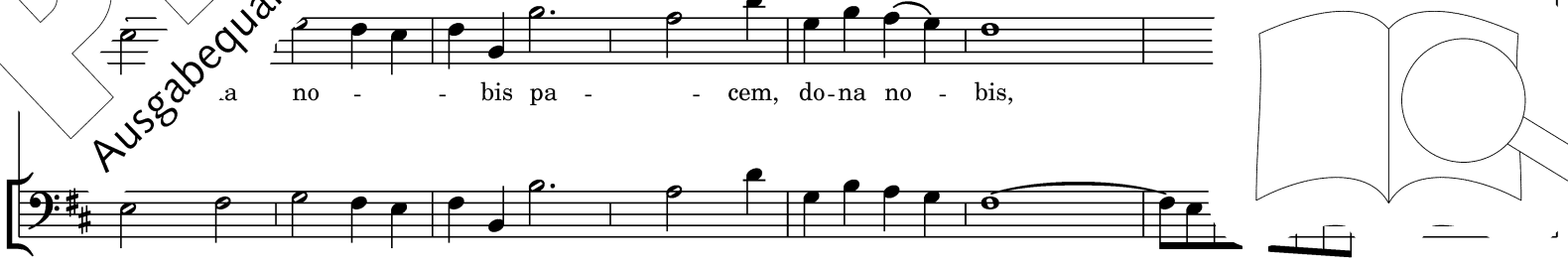
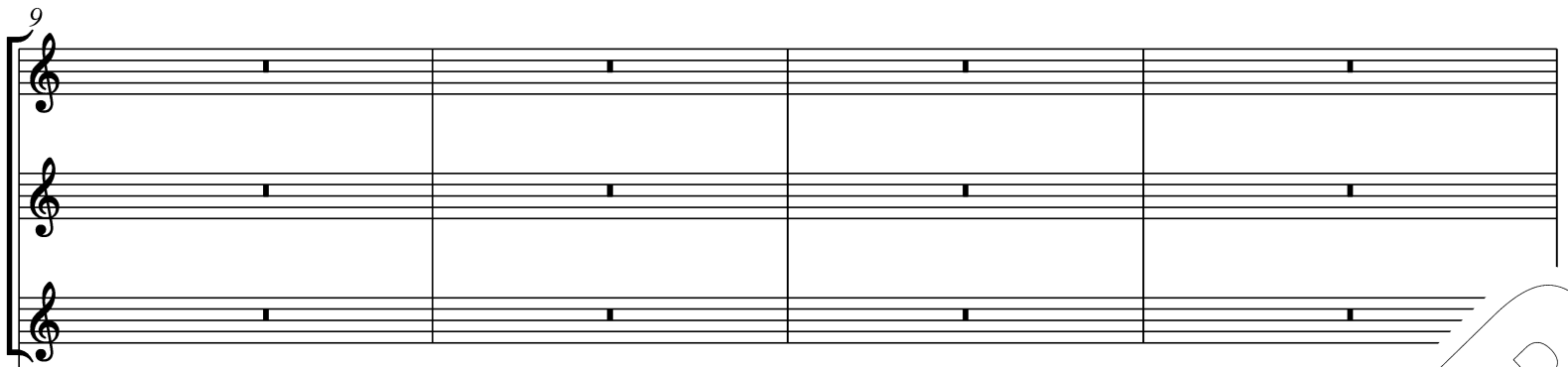

PROBEPARTITUR
Ausgabequalität gegenüber Original evtl. gemindert • Evaluation Copy - Quality may be reduced • Carus-Verlag

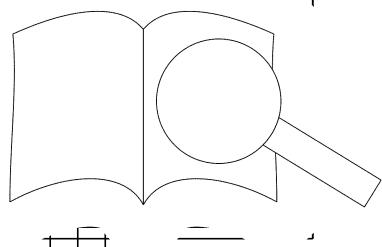

do - - - na no -
do - - - na no - - bis pa - cem,
- na no - - - bis pa - - cem, pa - cem do - na
pa - cem do - - - - -

PROBEPARTITUR
Ausgabequalität gegenüber Original evtl. gemindert • Evaluation Copy - Quality may be reduced • Carus-Verlag

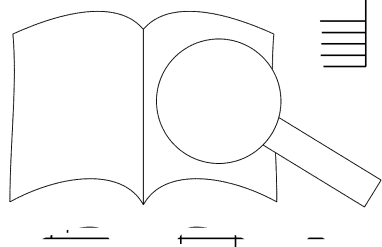

Musical notation for the first system, featuring a vocal line on a treble clef staff and piano accompaniment on a grand staff (treble and bass clefs).

Musical notation for the second system, continuing the vocal line and piano accompaniment.

Musical notation for the third system, continuing the vocal line and piano accompaniment.

Musical notation for the fourth system, including the vocal line with lyrics and piano accompaniment.

- bis pa pa - cem do -

no - - - bis pa - - - cem, pa - cem, pa -

- - - cem, pa - - - cem, do - na no - bis pa cem

Musical notation for the fifth system, including the vocal line with lyrics and piano accompaniment.

cem, do - - - - - na no -

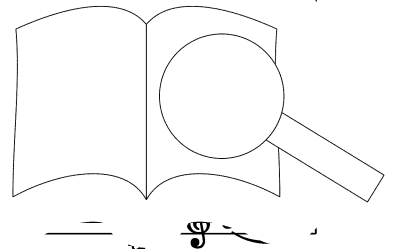

PROBEPARTITUR
 Ausgabqualität gegenüber Original evtl. gemindert • Evaluation Copy - Quality may be reduced • Carus-Verlag

Empty musical staves for vocal and piano accompaniment.

Musical notation for piano accompaniment, first system.

Musical notation for piano accompaniment, second system.

Musical notation for piano accompaniment, third system.

Musical notation for piano accompaniment, fourth system.

PROBEPARTITUR
 Ausgabequalität gegenüber Original evtl. gemindert • Evaluation Copy - Quality may be reduced • Carus-Verlag

bis, pa - - - cem do - na no - bis, pa -
 - - - na no - bis, do - - na no - bis
 pa - - - cem do - - - no -
 pa - -

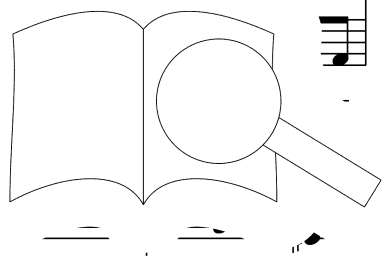

PROBEPARTITUR
 Ausgabequalität gegenüber Original evtl. gemindert • Evaluation Copy - Quality may be reduced • Carus-Verlag

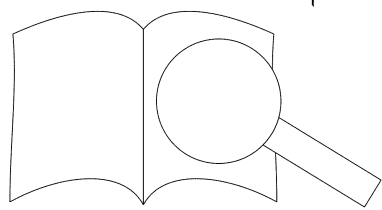

do - - - na no - - - bis pa - - - ce
 no - bis do - - na, pa - - cem, do - - na no - -
 do - - - na no - - - bis pa
 do - - - na no - - - bis pa - - ce

- bis p - cem, do - - - na - cem, do - na no - - bis pa - - - na no - bis pa - cem, do - na no - - - a no-bis pa - cem,

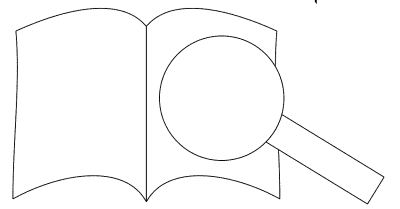

PROBEPARTITUR
 Ausgabqualität gegenüber Original evtl. gemindert • Evaluation Copy - Quality may be reduced • Carus-Verlag

no - - - - - cem, pa - - - - - cem, pa - - - - - cem,
 - - - - - cem, do - na pa - - - - - cem, do - - - - -
 - - - - - cem, do - - - - - na no - bis pa - - - - - cem, - - - - - na
 - na no - - - - - bis pa - - - - - cem, pa - - - - -

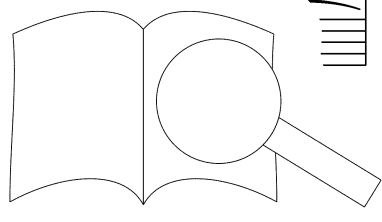

PROBEPARTITUR
 Ausgabqualität gegenüber Original evtl. gemindert • Evaluation Copy - Quality may be reduced • Carus-Verlag

do - no - bis, pa - - cem do - - na no - bis, do -

- cem, pa - cem, do - - - na no - - bis pa cem, cem, do -

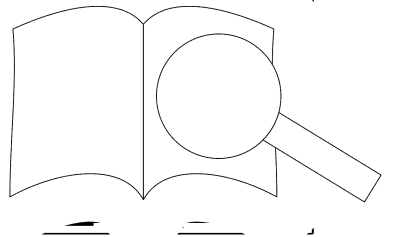

PROBE PAPIER
 Ausgabqualität gegenüber Original evtl. gemindert • Evaluation Copy - Quality may be reduced • Carus-Verlag

First system of musical notation, featuring a vocal line and piano accompaniment.

Second system of musical notation, featuring a vocal line and piano accompaniment.

Third system of musical notation, featuring a vocal line and piano accompaniment.

Fourth system of musical notation, featuring a vocal line with lyrics and piano accompaniment.

pa - - - na, do - - - na no - bis pa - cem.
 - bis pa - - - cem, do - na no - - - bis pa - cem.
 no - bis pa - - - cem, do - na no - bis pa - cem.
 a no - - bis pa - - cem, do - na no - bis pa - cem.

Fifth system of musical notation, featuring piano accompaniment.

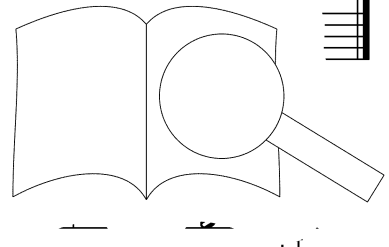

PROBEPARTITUR
 Ausgabqualität gegenüber Original evtl. gemindert • Evaluation Copy - Quality may be reduced • Carus-Verlag

Johann Sebastian Bach.

Hinweise zur Notation und Aufführungspraxis

Hauptquelle für die *Missa in h* von 1733, bestehend aus Kyrie und Gloria, ist der für Dresden bestimmte Originalstimmensatz (Quelle **B**). Diese Quelle ist weitgehend autograph; die Stimmen, deren Anfertigung anderen Schreibern anvertraut war, hat Johann Sebastian Bach gründlich durchgesehen und dabei mit aufführungspraktischen Anweisungen versehen. Für ein Dedikationsexemplar waren er und die weiteren an der Herstellung beteiligten Schreiber um gute Lesbarkeit und um größtmögliche Präzision bemüht. Für den zweiten Teil der *h-Moll-Messe* (10. *Credo*–23. *Dona nobis pacem*) ist die autographe Partitur (Quelle **A**) die maßgebliche Quelle.

Die aufführungspraktischen Angaben in den Stimmen sind unterschiedlich detailliert: Die Bezifferung des Continuo in **B 21** wurde vollständig vorgenommen; Bogensetzung und sonstige Artikulationszeichen sind zwar differenziert, aber selbst im Stimmenmaterial von Bach wohl nicht vollständig hinzugefügt worden. Der Stimmensatz bietet jedoch wesentliche klangliche Differenzierungen (in Form einer nicht-mechanischen Realisierung von *colla parte*-Instrumenten), die über die Angaben in der autographen Partitur **A** hinausreichen (siehe z.B. die Führung von Flöten und Oboen in 1. *Kyrie I* oder die Fagotte im Verhältnis zur Continuo-Stimme). Tempoangaben und dynamische Angaben finden sich selbst in den Stimmen nur vereinzelt. Es verstand sich für die Musiker von selbst, zurückhaltend zu spielen, wo ihnen reine Begleitfunktion zukam. Die Wahl des richtigen Tempos ergab sich aus der Notierung (Taktart und vorherrschende Notenwerte) und wurde von Bach nur vermerkt, wenn – wie am Beginn des Werkes – grobe Missverständnisse möglich waren oder wenn ein Abschnitt in einem neuen Tempo unmittelbar auf einen anderen Teilsatz folgte (siehe z.B. 7b. *Qui tollis* oder 9b. *Cum Sancto Spiritu*).

Die autographe Partitur **A** ist zwar meist gut lesbar, sie stellt aber die Erstniederschrift dar. Bei Abweichungen zwischen den Quellen **A** und **B** ist im Regelfall von Ad-hoc-Veränderungen Bachs auszugehen; ausgesprochen selten gibt es Kopierfehler, sie finden sich vor allem in den apographen Stimmen. Vereinzelt haben die Schreiber vergessen, Artikulationsangaben aus der Partitur **A** in die Stimmen **B** zu übertragen.¹

Grundprinzipien der Artikulation

Die Mehrzahl der Artikulationsangaben wurde von Bach beim Ausschreiben bzw. bei der Durchsicht der Stimmen hinzugefügt. Da er dabei keine Eintragungen in der Partitur vornahm, bleibt unklar, ob er die Stimmen wirklich mit der Partitur abgeglichen hat. Es erscheint jedenfalls unwahrscheinlich, dass Bach Dubletten (hier **B 17** mit **B 16** oder **B 21** mit **B 20**) untereinander verglichen hat. Dies kann zu deutlichen Abweichungen führen.

Bei der Artikulation sind bei Bach zwei unterschiedliche Verfahren, eine „stichwortartige“ und eine detailgenaue Notation, zu unterscheiden. Mit „stichwortartiger“ Bezeichnung ist gemeint, dass eine Artikulationsangabe einmal oder mehrere Male, meist am Satzbeginn, explizit eingetragen ist und die Anwendung auf Parallelstellen stillschweigend vorausgesetzt wird. Ein treffendes Beispiel ist der lombardische Rhythmus, den Bach in 7a. *Domine Deus* jeweils nur einmal in der Flöte (T. 1) und in den hohen Streichern (T. 27) eingetragen hat.² Selbst wenn Bach diese Artikulationswei-

se überhaupt nicht eingetragen hätte (wie dies bei der Partitur der Fall ist), hätte ein geschickter Musiker erkannt, dass dieser Satz eher im französischen als im italienischen Stil komponiert ist, und das Prinzip der „notes inégales“ selbstständig angewendet.

Im Dedikationsexemplar der *Missa in h* hat Bach die Artikulation überwiegend detailgenau eingetragen und zwar nicht nur bei solistischen Instrumenten, sondern auch bei chorisches besetzten Instrumenten (siehe z.B. die Violinstimme in 2. *Christe eleison*, die von mindestens drei Musikern gleichzeitig gespielt wurde).

Aufgrund von Bachs raschem Arbeitstempo bei der Bezeichnung der Stimmen sind gelegentlich unterschiedliche Artikulationsangaben bei Parallelstellen anzutreffen. Die Definition von Parallelstellen ist im Übrigen sehr eng zu sehen: Diese sind in der Regel beschränkt auf ton- und intervallgetreue Wiederholungen.

Aus Bachs Arbeitsweise ergibt sich, dass die Artikulationsangaben primär linear innerhalb jeder Einzelstimme gedacht sind; im Zusammenklang mehrerer Instrumente können sich daher unterschiedliche Artikulationsprinzipien überlagern. Eine Angleichung ist meist nicht erforderlich. Unterschiedliche Instrumentengruppen können unterschiedlich artikuliert werden, um spieltechnische Möglichkeiten der Instrumente optimal zu nutzen. Insbesondere weicht Bachs instrumentale Artikulation häufig von der Deklamation der Singstimmen deutlich ab. Dies kann zum Beispiel bei 6. *Gratias* oder 23. *Dona nobis* beobachtet werden, wo Bach trotz des Risikos einer undeutlicheren Deklamation Tonwiederholungen der Singstimmen in den Instrumentalstimmen tendenziell durch lang gehaltene Noten ersetzt. Eine behutsame Vereinheitlichung durch den Interpreten ist aber sicherlich dort erforderlich, wo zwei „gleiche“ Instrumente zufällig unterschiedlich artikuliert werden.

Bindebögen über mehr als zwei Noten werden vorzugsweise über Tonfolgen in Sekundschritten gesetzt, die Veränderung der Intervallstruktur (z.B. Ersatz einer Sekunde durch eine Terz) kann daher bereits zur Aufhebung der vorherrschenden Bogensetzung führen. Artikulationsbögen über Intervallen, die eine Quarte übersteigen, sind selten und kommen vorzugsweise fallend als Zweierbindungen vor. Artikulationsbögen zu mehr als vier Noten kommen insgesamt selten vor. Vor und nach Überbindungen wird meist neu angesetzt, es sei denn, es handelt sich um bloße Synkopen. Noten gleicher Tonhöhe und Tondauer können auch ohne weitere Kennzeichnung *portato* gemeint sein.

Hingewiesen sei bei Streichinstrumenten auf die sogenannte Abstrichregel. Dieses wichtige Artikulationsprinzip des Barockzeitalters, das wohl erstmals bei Georg Muffat in seinem *Florilegium Secundum* von 1698 verbal beschrieben wurde, besagt, dass im französischen Stil wichtige Noten, insbesondere die Taktschwerpunkte und der Beginn einer Kadenzformel, mit Abstrich zu spielen sind. Infolgedessen ist in geraden Taktarten in der Regel eine gera-

¹ Insgesamt erscheint es wahrscheinlicher, dass solche Eintragungen erst mit der Revision zur *Missa tota* Ende der 1740er-Jahre in Zusammenhang stehen.

² Es mag merkwürdig erscheinen, dass Bach den lombardischen Rhythmus erst in T. 27 und nicht in T. 2 in den Streicherstimmen vermerkt hat, wo diese Figur erstmals auftritt. Gemäß der Aufführungspraxis der Bach-Zeit steht aber zu erwarten, dass die Streicher in T. 2 die Artikulation, die sie gerade in der Flöte gehört hatten, nachgeahmt hätten.

de Anzahl von Artikulationsgruppen anzutreffen. Die Berücksichtigung der Abstrichregel kann daher in Zweifelsfällen eine Entscheidungshilfe bei der Interpretation eines unklaren Quellenbefundes liefern. Bei gleichartigen Spielfiguren ist es allerdings denkbar, dass zwei aufeinanderfolgende Takte gegenläufig artikuliert werden und erst auf der nächstfolgenden Taktheits wieder ein Abstrich erfolgt (siehe z.B. 2. *Christe eleison*, T. 34/35).

In Singstimmen kommen Bögen nur unregelmäßig, meist als melismatische Bögen vor; viele dieser Bögen, insbesondere in den Originalpartituren, stehen mit kompositorischen Änderungen Bachs in der Textunterlegung und Balkensetzung in Zusammenhang und dienen dann nur der Verdeutlichung der Lesart *post correcturam*.

Temporelationen und Fermaten

Bachs Verwendung von Fermaten oder „Schlusszeichen“ (d.h. Fermaten beim letzten Taktstrich, die manchmal durch ornamentale Hinzufügungen betont werden) dürfte anzeigen, dass der nachfolgende Satz in einem ganz anderen Tempo beginnt, während das Fehlen von Fermaten bedeuten könnte, dass eine einfache Beziehung zwischen dem Metrum der beiden aufeinanderfolgenden Abschnitte beachtet werden sollte. Eine strikte Tempobeziehung sollte insbesondere dort in Betracht gezogen werden, wo ein neuer Abschnitt ohne einen Taktstrich vor dem Taktwechsel beginnt (vgl. z.B. 18a. *Sanctus–18b. Pleni sunt coeli*).

Bezifferung

Bachs Bezifferung der Bc-Stimme **B 21** ist sehr detailliert und spiegelt subtile Veränderungen der Harmonien innerhalb eines Schläges wider, wohingegen die Generation seiner Söhne und Studenten das System vereinfacht hat, indem sie vor allem die grundlegenden Harmonien auf den Zählzeiten anzeigte. Trotz Bachs Interesse am musikalischen Detail scheint er die Bezifferung ohne Konsultation der Partitur eingetragen zu haben, wie an der gelegentlichen Vernachlässigung der Stimmführung der Mittelstimmen, insbesondere bei ausgeschriebenen Vorhaltsnoten, zu sehen ist. Die Bezifferung ist manchmal auch dort nachlässig, wo Vorhalte auf unbetonten Zählzeiten aufgelöst werden; an diesen Stellen schrieb Bach alle Ziffern übereinander, auch wenn sie zeitlich versetzt realisiert werden müssen.

Größe der Orchester- und Singstimmenbesetzung

Da Bach nicht für sein gewohntes Leipziger Ensemble, sondern für den Dresdner Hof schrieb, beschränkt sich der Stimmensatz **B** auf die obligaten Instrumente. Die Anfertigung von Duplierstimmen blieb den Aufführenden in Dresden überlassen. Auch von der Stimme *Violino I* gibt es nur deswegen zwei Exemplare, weil **B 17** keine exakte Kopie von **B 16** ist; letztere Stimme enthält nämlich für 5. *Laudamus te* die Partie der Solovioline. Entsprechend gibt es zwei instrumentale Basstimmen, weil sich die Violoncello-Stimme vom Orgel-Continuo in 7b. *Qui tollis* unterscheidet. Dass der Orgel-Continuo entgegen Bachs Leipziger Praxis untransponiert ist, ist wahrscheinlich darauf zurückzuführen, dass Bach die Anpassung an den Stimmtton der Orgel für eine Dresdner Aufführung den dortigen Musikern überließ. Damit können aus dem Stimmensatz auch keine Informationen über die intendierte Größe des Chores gewonnen werden. Vereinzelt Angaben wie „Solo“ (bei der Altstimme in 8. *Qui sedes* oder dem Vokalbass in 9a. *Quoniam*) sprechen gegen die öfters geäußerte Theorie „ein Sänger pro Stimme“. Ein „Tutti“-Vermerk um die „Solo“-Anweisungen zu widerrufen war am Beginn von 9b. *Cum Sancto Spiritu* nicht notwendig, da der Schlusssatz der Missa offensichtlich vom Gesamtensemble zu musizieren war. Während die Missa einen fünfstimmigen Chor mit zwei Sopranen erfordert, werden die vokalen Kräfte im Sanctus

zu zwei Sopranen, zwei Altstimmen, Tenor und Bass und im Osanna sogar zu einem echten Doppelchor aufgefächert. Auch dies macht es unwahrscheinlich, dass Bach jemals eine Aufführung der Missa, aus der später die *h-Moll-Messe* hervorging, mit nur einem Sänger pro Stimme beabsichtigt haben könnte.

Zu den einzelnen Sätzen

Im Folgenden werden v.a. die Grundsätze der Artikulation für jeden einzelnen Satz kurz beschrieben; geringfügige Abweichungen von diesen Mustern, die als ungenaue Notation oder bloße Kopierfehler gedeutet werden können (dies gilt insbesondere für die nicht-autographen Stimmen), werden in den Einzelanmerkungen des Kritischen Berichts nicht eigens angeführt.

I. Missa

1. Kyrie I

In den Instrumentalstimmen werden die kleinen Sekunden (gelegentlich auch die großen Sekunden) mit einem Bindebogen versehen, um als Seufzer artikuliert zu werden, wenn der Sekundschritt zwischen der zweiten und dritten Note einer Vierergruppe liegt. Diese Notation ist gelegentlich auch in den Gesangspartien anzutreffen und zwar selbst dann, wenn die Textunterlegung lange Melismen aufweist; diese Bögen wurden in der Edition beibehalten. Ausnahmsweise sind Halbtonschritte in Instrumentalstimmen auch zwischen der vierten Note einer Gruppe und der ersten Note der nachfolgenden Vierergruppe mit einem Bogen versehen; diese isolierten Bögen wurden in die Edition nicht übernommen, sondern nur in den Einzelanmerkungen angeführt.

In der Partitur sind die Flöten nicht auf einem separaten System, sondern zusammen mit den Oboen notiert. Offensichtlich liegt die Partie von Oboe II für eine Querflöte in T. 30ff. zu tief. In der Partitur gibt es aber weder einen Hinweis für Pausen noch für den Wiedereintritt der Flöte in T. 48ff. Ab T. 74ff. werden die Flöten jeweils mit Violine I und II geführt, aber sie springen schon in T. 78 wieder auf eine *colla-parte*-Führung mit den Oboen zurück. Der Stimmensatz macht deutlich, dass einzelne Noten, die unterhalb des Stimmumfangs der Flöte liegen, eher ausgelassen als in die Oberoktave versetzt wurden. Manchmal ersetzte Bach tiefe Töne aus Gründen der Stimmführung auch durch einen anderen Ton der Grundharmonie.

2. Christe eleison

Die Violinstimme enthält schon in der Partitur die meisten der Bögen über Gruppen von Noten in schrittweiser Bewegung. Gelegentlich werden die Noten paarweise gebunden, auch wenn längere Bögen nach diesem Prinzip möglich gewesen wären. Beim Schreiben der Stimmen hat Bach zahlreiche Staccatopunkte hinzugefügt, um deutlich zu machen, dass die Bögen nicht über die ganze Vierergruppe verlängert werden sollten. In diesem Satz weist die Violinstimme *piano*- und *forte*-Angaben auf, um die instrumentalen Zwischenspiele von rein begleitenden Passagen zu unterscheiden; in der Continuo-Stimme stehen in der Partitur überhaupt keine dynamischen Bezeichnungen, und nur wenige Angaben, die denen in der Violinstimme entsprechen würden, finden sich in den entsprechenden instrumentalen Basstimmen.

3. Kyrie II

Der Einsatz von Instrumenten ist in **A** nur durch die Überschrift „Stromenti in unisono.“ angedeutet. Der Umfang der Altstimme ist offensichtlich zu tief für eine Querflöte, dementsprechend gehen im

Stimmensatz beide Flöten mit dem Sopran. Die Angabe „Allabreve“ findet sich in Partitur und Stimmen. Mit wenigen Ausnahmen weisen die Partitur und die autographen Stimmen kurze Taktstriche in der Mitte jedes Einzeltaktes auf. In **B** ergänzte Bach Bögen für Fl I: 44/5–6, 7–8, 47/3–4; Fl II: 44/5–6, 7–8; Ob I: 44/5–6, 7–8, 46/1–2, 47/3–4; Vl I: 44/5–6, 7–8; Vl II, Ob II: 44/1–2, 3–4; Va: 6/4–5, 26/6–7, 45/5–6, 7–8, 46/1–2, 57/5–6, 58/1–2, 3–4.

4a. Gloria in excelsis Deo

Keine berichtenswerten Besonderheiten.

4b. Et in terra pax

Der Satz folgt unmittelbar auf 4a. *Gloria in excelsis Deo*; es gibt keinen Taktstrich vor der neuen Taktvorzeichnung in T. 101. Bach versieht Achtelnoten (bei denen die erste manchmal auch eine synkopierte Viertelnote ist) paarweise mit Bogen, und zwar auch bei großen Intervallen wie Oktavsprüngen oder Nonen.

5. Laudamus te

Das Solo-Instrument ist in der Partitur als „Violino Concertato.“ bezeichnet. Fast alle Artikulationszeichen (Bindebögen und Staccatopunkte) finden sich für diesen Satz bereits in der Partitur. Während die Tutti-Streicher in den Soloabschnitten meist die Angabe *piano* aufweisen, werden sie in einigen Abschnitten, in denen sie die vokale Solostimme begleiten, *pianissimo* geführt.

6. Gratias agimus tibi

Die Instrumente sind in der Partitur teilweise *colla parte* notiert, insbesondere am Satzbeginn. Beim Ausschreiben der Stimmen hat Bach Tonwiederholungen meist durch längere Notenwerte ersetzt. Wie in 3. *Kyrie II* haben Partitur und Stimmen mit wenigen Ausnahmen kurze Taktstriche in der Mitte jedes Einzeltaktes.

7a. Domine Deus

Während in der Partitur das oberste Notensystem mit „Travers. in unisono“ bezeichnet ist, ist die Solostimme im Stimmensatz nur Fl I zugewiesen. Bach notierte in den Stimmen in T. 1 (Fl I) und T. 27 (Archi) einen lombardischen Rhythmus anstelle gewöhnlicher Sechzehntelnoten. Es steht zu vermuten, dass diese Artikulation auf den ganzen Satz konsequent ausgedehnt werden kann.

7b. Qui tollis

Der Satz folgt unmittelbar auf 7a. *Domine Deus*; es gibt keine Taktstriche vor dem Taktwechsel in T. 96. „Lente“ findet sich nur in den Stimmen. Erst im Nachhinein unterschied Bach beim Continuo zwischen dem (Orgel)-Continuo und einem Violoncello. Diese Unterscheidung ist in den Stimmen vollständig realisiert (zum Auftakt T. 96 siehe die Einzelanmerkungen). Für die Bogensetzung zeichnen sich zwei verschiedene Prinzipien ab: Während die Vierergruppen in der Regel durchgehend gebunden sind, wenn aufeinanderfolgende Noten unterschiedliche Tonhöhen haben (auch wenn sich zwischen ihnen Terzsprünge befinden), werden sie paarweise gebunden, wenn die 2. und 3. Note einer Vierergruppe dieselbe Tonhöhe aufweisen. Die Notierungsweise ist nicht ganz konsequent, wenn die erste Note einer Gruppe an die vorhergehende angebunden ist: In den meisten Fällen steht dann bei den ersten beiden Noten kein Bogen, so dass dies im Rahmen der Edition als das von Bach intendierte Artikulationsmodell angesehen wird (vgl. die Einzelanmerkungen).

8. Qui sedes

In den Begleitstimmen unterschied Bach differenziert zwischen Bindebögen und Staccatopunkten. Die „Seufzer“-Figuren (siehe z.B.

T. 4 und T. 16) sollen offenbar leiser als die umgebenden Noten gespielt werden (*piano* vs. *forte* oder *pianissimo* vs. *piano*), aber Bach hat die Rückkehr zur lauterer dynamischen Ebene nicht immer angezeigt. Die an sich selbstverständliche Angabe „Solo“ für Obda I und Alto steht nur in den Einzelstimmen. Die Notation in der Partitur und in den Stimmen ist etwas ungenau hinsichtlich der Bogenlänge; in Zweifelsfällen wurde für die Edition angenommen, dass längere Bögen (in der Regel zu drei Achtelnoten mit gleicher Bewegungsrichtung, es sei denn, die Gruppe beginnt oder endet mit einer übergebundenen Note) gegenüber kürzeren bevorzugt werden. Für Gruppen von sechs Sechzehntelnoten in der Obda-Stimme hat Bach unterschiedliche Prinzipien angewendet: Während in der Partitur überwiegend lange Bögen zu allen sechs Noten stehen, bevorzugt er in **B 13** zwei Bögen (zu den Noten 1 und 2 bzw. den Noten 3 bis 6), wenn das Intervall zwischen der 2. und 3. Note eine Terz ist. Gelegentlich (siehe z.B. T. 76ff.) werden Gruppen von sechs Noten paarweise gebunden, obwohl die Melodie stufenweise fortschreitet.

9a. Quoniam tu solus sanctus

Weder die Partitur noch die zugehörige Stimme geben die Oktavlage des Corno da caccia an; dies hat lange Debatten unter Bach-Forschern ausgelöst.³ Soweit wir heute wissen, wurden keine hohen Hörner für Solopartien in der Dresdner Hofkapelle, für die die *Missa in h* bestimmt war, verwendet. Darüber hinaus erscheint es angesichts des dunklen Timbres des Bassolisten, der von zwei Fagotten und Basso continuo begleitet wird, schon aus ästhetischen Gründen wahrscheinlicher, dass ein Corno da caccia *in D basso* gemeint ist. Der Verzicht auf dynamische Angaben in der Hornstimme (im Gegensatz zu den Fagottstimmen) bedeutet nicht, dass die Stimme durchgängig *forte* zu spielen wäre.

9b. Cum Sancto Spiritu

Dieser Satz schließt in der Partitur unmittelbar an 9a. *Quoniam tu solus sanctus* an. Bach verwendet die bisherigen Systeme der Horn- und Fagottstimmen im nachfolgenden „Cum Sancto Spiritu“ für die Soprane I und II sowie für den Alt; er notierte deshalb die jeweils letzte Note der Bläserstimmen in der Partitur als Achtelnote mit Fermate. Die Edition folgt der präziseren Notierung der Stimmen.

Das vorausgehende „Quoniam“ ist der einzige Satz mit zwei (obligaten) Fagottstimmen. Die Angabe „due Bassoni in unisono“ in der Fagottstimme **B 15** am Anfang von 9b. *Cum Sancto Spiritu* verleitet uns zu der Annahme, dass die zwei Fagotte auch in den anderen Sätzen gemeinsam spielen sollen.

Die Verwendung von Flöten ist in der Partitur am Satzbeginn nicht angegeben, ihre Verwendung verstand sich nach Bachs Gewohnheit von selbst, da der Eingangs- und Schlusssatz groß besetzter Vokalwerke in der Regel für die gleiche Besetzung bestimmt waren. Die Flöten haben nur ab T. 238 eigene Systeme (mit der Angabe „Traversieri“) erhalten. Bach fügte am Ende des Satzes, der ursprünglich den Schlusssatz der *Missa in h* von 1733 bildete, die Formel „Fine S. D. Gl.“ [Fine Soli Deo Gloria] an.

II. Symbolum Nicenum

Für die Sätze ab 10. *Credo in unum Deum* ist die autographe Partitur **A** die maßgebliche Quelle. Wie im Vorwort ausgeführt, müssen die beiden frühen Abschriften **C** und **D** konsultiert werden, um Änderungen von Carl Philipp Emanuel Bach, die mit einer Auffüh-

³ Zur Fachdiskussion und zu instrumentenbaulichen Nachweisen siehe *Johann Sebastian Bach, Frühfassungen zur h-Moll-Messe. Kritischer Bericht*, NBA II/1a, hrsg. von Uwe Wolf, Kassel u.a. 2005, S. 28–30.

rung des Credo (Satz 10–17) im Jahr 1786 in Zusammenhang stehen, rückgängig zu machen.

10. Credo in unum Deum

Trotz der Alla-breve-Notation stehen keine kurzen Taktstriche in der Mitte der Einzeltakte. Die Eingangstakte weisen eine Bezifferung auf, die offenbar aus Bachs Vorlage (siehe Einzelanmerkungen) übernommen wurde.

11. Patrem omnipotentem

Keine berichtenswerten Besonderheiten.

12. Et in unum Dominum

Die Partitur ist mit Akkoladen von sechs Systemen notiert; die Mitwirkung von Oboen wurde von Bach durch Angaben wie „Violine solo“, „Soli“ und „Tutti“ angezeigt. Einige, aber nicht alle dieser Angaben wurden später von Carl Philipp Emanuel Bach getilgt und sind kaum noch zu erkennen. Die Violinstimmen unterschreiten den Stimmumfang einer Barockoboe nur selten. Es ist daher nicht notwendig, Oboi d'amore vorzuschreiben. Es ist eher anzunehmen, dass Bach eine pragmatische Lösung gesucht hätte, wenn er Aufführungsstimmen revidiert oder selbst geschrieben hätte. In der Edition stehen in der Einzelstimme für Ob II entsprechende Vorschläge des Herausgebers.

13. Et incarnatus est

Keine berichtenswerten Besonderheiten.

14. Crucifixus

Die Notation der Portato-Bögen in der Bassstimme ist nicht ganz konsistent. Für die Edition wurde angenommen, dass Portato-Bögen jeden Einzeltakt umfassen sollen, obwohl Bach entsprechende Bögen manchmal überhaupt nicht oder nur zu den Noten 3 bis 6 gesetzt hat, wenn die ersten beiden Noten eine andere Tonhöhe als die nachfolgenden haben.

15. Et resurrexit

Der Einsatz von Fl II wird erst ab T. 8 (nach Seitenwechsel) angegeben; in der Edition wird das Prinzip, das sich ab T. 14 zeigt, auch auf die Anfangstakte angewendet.

16. Et in Spiritum Sanctum

Die Notation der Partitur ist hinsichtlich der Bogenlänge etwas unpräzise; für die Edition wurde im Zweifel angenommen, dass längere Bögen (in der Regel zu drei Achtelnoten mit gleicher Bewegungsrichtung) gegenüber kürzeren bevorzugt werden, es sei denn, die Gruppe beginnt oder endet mit einer Überbindung. Der isolierte Bogen in T. 8 (Bc) dürfte zeigen, dass Bach hier gegen seine Gewohnheit Bindebögen zu drei Achtelnoten auch dann setzt, wenn Oktavsprünge vorkommen.

Für die Aufführung von 1786 fügte Carl Philipp Emanuel Bach zahlreiche Ornamente, Legatobögen und Artikulationszeichen hinzu. Die Angabe „Auch ohne Hob. mit 2 Viol.“ in **A** zeigt, dass der Hamburger Bach für die Aufführung die inzwischen ungebräuchlichen Oboi d'amore durch zwei Solo-Violinen ersetzt hatte.

17a. Confiteor–17b. Et expecto

Am Satzanfang gibt es keinen Hinweis auf die Verwendung von Instrumenten. Da die Instrumente nach einigen expliziten Pausentakten in T. 147 einsetzen, ohne dass die entsprechenden Systeme bezeichnet wären, ist es wahrscheinlich, dass 17a. *Confiteor* und der Beginn von 17b. *Et expecto* wirklich *a cappella*, d.h. ohne col-

la-parte-Instrumente gemeint sind. Ferner ist in einem fünfstimmigen Satz nicht selbstverständlich, welche Instrumente welchen Stimmen zuzuordnen wären, sodass eine entsprechende Angabe erforderlich gewesen wäre.

III. Sanctus

18a. Sanctus

Die Notation der Partitur legt für den Anfangsabschnitt des Satzes nahe, dass punktierte Rhythmen (♩) in einem Verhältnis von 2:1 an die Triolen angeglich werden sollen. Darüber hinaus suggerieren die Bögen in Tr I und Tr II (T. 1–3), dass Triolen grundsätzlich gebunden werden sollen, was bis wenigstens 1760 wohl ohnehin allgemeine Praxis war.⁴ Dieser Satz ist der einzige, der drei statt der sonst üblichen zwei Oboen verlangt; bei einer Aufführung im 18. Jahrhundert hätte dieser Part wahrscheinlich von einem anderen Holzbläser, z. B. einem Flötisten, übernommen werden sollen.

18b. Pleni sunt coeli

Keine berichtenswerten Besonderheiten.

IV. Osanna, Benedictus, Agnus Dei et Dona nobis pacem

19. Osanna in excelsis

Bach behandelt die letzte Silbe von „Osanna“ und die darauffolgende Silbe „in“ in der Regel als eine Einheit. Es bleibt unklar, ob das Prinzip der Silbenverschleifung (Synalöphe) auf eine italienische Aussprache des lateinischen Textes deutet.

20. Benedictus

Das Solo-Instrument ist in der Partitur nicht spezifiziert; die vergleichsweise hohe Lage und die Annahme, dass ein Gegensatz zwischen 20. *Benedictus* und 22. *Agnus Dei* beabsichtigt war, machen es wahrscheinlicher, dass diese Stimme für eine Querflöte als für eine Violine bestimmt war. Die isolierte Verwendung von *dis*¹ als Wechselnote auf unbetonter Taktzeit in T. 38 schließt die Verwendung einer Querflöte nicht aus. Die Notation der Partitur ist dahingehend ziemlich konsistent, dass Gruppen von Triolen gebunden werden, während Noten mit Haltebogen nicht an die nachfolgenden kürzeren Noten angebunden werden sollten.

21. Osanna repetatur

Dieser Satz ist in der Originalpartitur nicht ausgeschrieben.

22. Agnus Dei

Keine berichtenswerten Besonderheiten.

23. Dona nobis pacem

Der Satz basiert auf 6. *Gratias agimus tibi*. Anders als in der Vorlage hat Bach die Instrumente hier ausgeschrieben; allerdings haben die Fagotte kein zusätzliches System erhalten und werden auch nicht namentlich angeführt. In der Edition wurde eine Fagottstimme vom Herausgeber analog 6. *Gratias agimus tibi* ergänzt, die – wie im Originalstimmensatz der Missa – eher dem Vokalbass-Part als dem Continuo entspricht. Auch wurden kurze Taktstriche in der Mitte jedes Einzeltakts gesetzt, obwohl diese in der Partitur nicht stehen.

⁴ In der Vorlage, dem Sanctus BWV 232^{III}, finden sich in den Originalstimmen (Staatsbibliothek zu Berlin – Preußischer Kulturbesitz, Signatur *Mus. ms. Bach St 117*) Zweierbögen auch zu den meisten punktierten Noten.

Issues of notation and performance practice

The main source for the *Missa in B* of 1733, consisting of the movements Kyrie and Gloria, is the original set of parts destined for the Dresden court (source **B**). This source is mainly autograph; Johann Sebastian Bach thoroughly revised those parts that he had entrusted to other scribes, and in the process provided indications on performance practice. For the dedication copy Bach and the other scribes strived for good readability and for the greatest possible precision. For the second part of the *B-minor Mass* (10. *Credo*–23. *Dona nobis pacem*) the autograph score (source **A**) is the sole relevant source.

The specifications regarding performance practice in the parts show different levels of detail: Figuration was fully added by Bach in the continuo part **B 21**; slurs and other articulation marks are highly differentiated, but not even in the set of parts can they claim to be complete. As a non-mechanical realization of instruments notated *colla parte* in the score, the set of parts also clarifies the instrumentation; Bach's intention could not always be derived from the autograph score **A** alone (see, e.g., the use of flutes as opposed to the oboes in 1. *Kyrie I* or the bassoon part in relationship to the continuo part). Tempo and dynamic markings are only found sporadically in the parts and even less so in the autograph score. For musicians of Bach's time, it went without saying that they were to play softly whenever they assumed mere accompanimental functions. The choice of the proper tempo resulted from the notation and was to be derived from the time signature and the prevailing note values; verbal tempo indications were generally regarded as unnecessary, unless – as in the beginning of the work (1. *Kyrie I*, mm. 1 and 5) – gross misunderstandings were possible or a section in a different tempo immediately followed another partial movement (e.g. 7b. *Qui tollis* or 9b. *Cum Sancto Spiritu*).

Although the autograph score **A** is very legible, it is largely a first draft. For variants between the sources **A** and **B** it is assumed as a general rule that they are ad-hoc changes by Bach; rarely there are apparent copying errors and these are usually restricted to those parts that Bach did not copy himself. Occasionally copyists forgot to transfer articulation marks from the score **A** when the parts **B** were written out.¹

General principles of articulation

Most articulation marks were added by Bach when writing out or revising parts. Since he left no marks in his score, it remains unclear whether or not he actually compared the parts to the score when revising them. In any case, it seems very unlikely that Bach compared duplicate parts (in this case **B 17** and **B 16** or **B 21** and **B 20**) to each other. This can lead to notable discrepancies.

With respect to articulation, two different methods should be distinguished, a “shorthand” notation and a detailed notation. By “shorthand” notation we mean that Bach specified the principle of articulation explicitly one or a few times, typically at the beginning of a movement, under the assumption that the player would tacitly apply it to parallel instances. An obvious example is the Lombardic rhythm that Bach entered only once into the flute (m. 1) and upper string parts (m. 27) of 7a. *Domine Deus*;² even if Bach had not specified the articulation (as in the score) a skilled performer

would probably have recognized that this movement is in the French rather than the Italian style and thus have applied this principle of “notes inégales” himself.

In the dedication copy of the *Missa in B* Bach has entered the articulation, however, overall in a very detailed manner and he did so not only for solo instruments, but also in “choral” settings (see, e.g., the violin part in 2. *Christe eleison*, which was played by at least three violinists).

As a result of the rapid pace of Bach's preparation of the parts, parallel passages have not always been treated the same way. For Bach's music, it is recommended to define “parallel passages” in a very narrow manner, namely limited to exact repetitions at the same pitch or to repetitions that respect the original interval structure.

It results from Bach's working habits that the details of articulation for each individual part are derived primarily in a “linear” manner, without taking other parts into account. This can result in an overlap of different principles of articulation; an adaptation is usually not required. Different groups of instruments can be articulated differently in order to make use of idiomatic playing techniques of the instruments. In particular, Bach's articulation for instruments often deviates significantly from the declamation of vocal parts. This can be seen for example in 6. *Gratias agimus tibi* or 23. *Dona nobis pacem*, where Bach tends to replace repetitions in the vocal parts by long held notes in the instruments at the risk of obscuring the declamation of the text. A careful standardization by the performers, however, is certainly required where two “equal” instruments are articulated differently at the same time without apparent reason.

Slurs on more than two notes are preferably placed on tone sequences in stepwise motion; a change in the interval structure (e.g., the replacement of the interval of a second by a third) can therefore already lead to the repeal of the prevailing slurring. Articulation slurs over intervals exceeding a fourth are rare and typically occur on pairs of notes in falling direction. Slurs rarely extend groups of more than four notes. Tied notes are rarely included in the slurs unless they are mere syncopations; rather, slurs end before and resume after the pair of tied notes. Notes of the same pitch and duration are likely intended to be *portato* without any further indication.

Mention should be made for the strings of the so-called “rule of the down-bow.” This important articulation principle of the Baroque period, which has probably first been described verbally by Georg Muffat in his *Florilegium Secundum* of 1698, stating that in the French style important notes, particularly the downbeats and

¹ Overall, it is more likely that these entries were only added to the full score during the late 1740s when Bach revised the score in the context of expanding the *Missa* of 1733 to a *Missa tota*.

² It may appear strange that Bach entered the Lombardic rhythm in the string parts only in m. 27 and not in m. 2 where the figure occurs for the first time. It is to be assumed according to performance practice of Bach's time, however, that the strings would have imitated in m. 2 what they had just heard from the flutist.

the beginning of a cadence are stressed, i.e., to be played with a down-bow. As a result, in even numbers of measures an even number of bowings is typically to be expected. Taking into account the “rule of the down-bow” can therefore aid the interpretation in cases of doubt, particularly if the notation of the source is not absolutely precise. If a principle of articulation is applied to several measures immediately following each other, it is conceivable that two consecutive downbeats are bowed in opposite directions and that a down-bow occurs only at beat 1 of every other measure (see, e.g., 2. *Christe eleison*, mm. 34–35).

In vocal parts slurs are only irregularly found, usually as melismatic slurs. Many of these instances seem to result from changes of the positioning of the text underlay and the beaming during the compositional process and thus serve mainly to clarify the intended reading *post correcturam*.

Tempo relationships and fermatas

Bach’s use of fermatas or “Schlusszeichen” (i.e., fermatas at the final bar line, sometimes emphasized by ornamental additions to the final bar line) seems to indicate that the subsequent movement starts in an entirely different tempo while the lack of fermatas might signify that a simple relation between the beats of the two subsequent sections ought to be observed. A strict tempo relationship should particularly be considered if a new section starts without a bar line before the meter change (cf., e.g., 18a. *Sanctus–18b. Pleni sunt coeli*).

Figuration

Bach’s figuration of the continuo part **B 21** is very detailed and reflects subtle changes of harmonies within a beat whereas the generation of his sons and students simplified the system by mainly marking the basic harmonies on the beats. Despite Bach’s interest in the musical detail, it appears that Bach often added the figuration without consulting the score, as can be derived from the occasional neglect of the voice-leading of the middle voices, particularly written-out suspended notes. The notation is also sometimes lax when suspensions are realized off-beat; there Bach wrote all figures on top of each other on the beat, even if they were to be realized in succession.

Size of orchestral and vocal forces

Since Bach was not working with his usual Leipzig ensemble, but for the Dresden court, the set of parts **B** is restricted to the obligatory parts, leaving it to the discretion of the Dresden performers to provide additional duplicate parts if needed. Two copies of the first violin part were only provided because **B 17** is not an exact duplicate copy of **B 16**, which contains the *Violino concertato* part for 5. *Laudamus te*. Similarly there are two instrumental bass parts, because the violoncello part differs from the organ continuo in 7b. *Qui tollis*. Also the observation that the organ continuo differs from Bach’s Leipzig habits in that it is notated at pitch probably results from the fact that Bach left it to the discretion of the Dresden musicians to adapt the part to the tuning of the organ for a performance there. Thus no information about the intended size of the chorus can be derived from the parts. Occasional entries such as “solo” for the alto part in 8. *Qui sedes* or the vocal bass part of 9a. *Quoniam tu solus sanctus* speak against the often-uttered “one singer per part” theory. A “tutti” indication revoking the solo indication was not needed at the beginning of 9b. *Cum Sancto Spiritu*, since obviously the concluding movement of the Missa would have been performed by the entire ensemble. While the Missa makes use of a five-part chorus with two sopranos, the vocal

forces are split up in the Sanctus into two sopranos, two altos, tenor and bass and in the Osanna even into a real double choir. This also makes it unlikely that Bach may ever have intended a performance of the Missa (from which the *B-minor Mass* was derived) with just one singer per part.

On the individual movements

In the following, especially the principles of articulation are briefly described for each individual movement; slight deviations from these models that can be understood as an inaccurate notation or a copying error, particularly in non-autograph parts, are not listed singly in the Individual Remarks.

I. Missa

1. Kyrie I

In the instrumental parts the minor seconds (occasionally also major seconds) of the main theme are slurred to be articulated as sighs if the second step occurs between notes 2 and 3 of a group of four. This notation is occasionally also found in the vocal parts even where the text underlay has long melismas; these slurs have been retained in the edition. Exceptionally, half-tone steps are slurred in instrumental parts also between note 4 of one group and note 1 of the following group of four; these isolated slurs have not been observed in the edition, but are listed in the Individual Remarks.

In the score, the flutes are not written on a separate staff but together with the oboes. Obviously, the oboe II part is too low for a transverse flute in mm. 30ff., but, in the score, there is neither an indication for rests nor for the re-entry of the flute in mm. 48ff. In mm. 74ff. the flutes are notated with VI I and VI II respectively, but they switch back to *colla parte* with the oboes in m. 78. The set of parts makes it clear that individual notes in the flute parts below their range are rather to be left out than to be played at the higher octave; for better voice leading Bach sometimes replaced low notes by a different note of the underlying harmony.

2. Christe eleison

The violin part in the score already contains most of the slurs over groups with stepwise motion. Occasionally, notes are slurred in pairs even when longer slurs would have been possible according to this principle. When writing out the parts Bach added numerous staccato dots to make clear that the slurs were not meant to extend over entire groups of four notes. In this movement the violin part has *piano* and *forte* markings, to distinguish the instrumental interludes from merely accompanimental passages; in the continuo part no dynamic markings were entered into the score and only few of these markings that would correspond to those in the violin part are found in the instrumental bass parts.

3. Kyrie II

The use of instruments in **A** is indicated only by the heading “Stromenti in unisono.”; the range of the alto part is obviously too low for a transverse flute (consequently, in the set of parts both flute parts follow the soprano part). The indication “Allabreve” is found in the score and the parts. With few exceptions the score and the autograph parts have short bar lines in the middle of each measure. In the set of parts **B** Bach added slurs in the following instances: Fl I: 44/5–6, 7–8, 47/3–4; Fl II: 44/5–6, 7–8; Ob I: 44/5–6, 7–8, 46/1–2, 47/3–4; VI I: 44/5–6, 7–8; VI II, Ob II: 44/1–2, 3–4; Va: 6/4–5, 26/6–7, 45/5–6, 7–8, 46/1–2, 57/5–6, 58/1–2, 3–4.

4a. Gloria in excelsis Deo
No particularities to report.

4b. Et in terra pax

The movement immediately follows 4a. *Gloria in excelsis Deo*; there is no bar line before the new meter in m. 101. Bach almost consistently slurred the eighth notes (the first of which sometimes being a syncopated quarter note) in pairs, even for large intervals such as octave leaps or ninths.

5. Laudamus te

The solo instrument is labeled "Violino Concertato." in the score. For this movement, almost all articulation marks (slurs and staccato dots) are already found in the score. While the tutti strings are marked *piano* during most of the solo sections, they have *pianissimo* in some sections in which they accompany the vocal solos.

6. Gratias agimus tibi

The instruments are partly notated *colla parte* in the score, particularly at the beginning of the movement. When writing out the parts, Bach mostly replaced tone repetitions by longer note values. As in 3. *Kyrie II*, with few exceptions the score and the parts have short bar lines in the middle of each measure.

7a. Domine Deus

While in the score the upper staff is labeled "Travers. in unisono," the solo part is assigned only to Fl I in the set of parts. Bach notated a Lombardic rhythm instead of regular 16th notes in mm. 1 (Fl I) and 27 (Archi). It is to be assumed that this articulation can be applied consistently throughout the movement.

7b. Qui tollis

The movement immediately follows 7a. *Domine Deus* with no bar lines before the meter change in m. 96. The tempo indication "Lente" is found only in the parts. Only as an afterthought Bach made a distinction in the continuo part between the (organ) continuo and a violoncello. This distinction is fully realized in the set of parts (for the upbeat to m. 96 see the Individual Remarks). For the slurring, two different principles can be observed: While groups of four notes are usually slurred together, when consecutive notes have different pitches (even if they contain leaps of a third), the notes are slurred in pairs if notes 2 and 3 of a group of four are at the same pitch. The notation is not entirely consistent if the first note of a group is tied to the previous one: then, in most cases, no slur is found for the first two notes, so this has been regarded as Bach's intended model for articulation in the present edition (cf. the Individual Remarks).

8. Qui sedes

In the accompaniment, Bach carefully distinguished between slurs and staccato dots. The "sigh" figures (e.g. mm. 4, 16) are apparently to be played softer than the surrounding notes (*piano* versus *forte* or *pianissimo* versus *piano*), but Bach did not always indicate the return to the louder dynamic level. The self-evident "solo" indications for Obda I and Alto are only found in the individual parts. With respect to the length of slurs, the notation is somewhat imprecise in the score and the set of parts; in doubtful cases it has been assumed for the edition that longer slurs (typically on three eighth notes in the same direction, unless the group begins or ends with a tied note) are preferred to shorter ones. For groups of six 16th notes in the Obda part Bach applies different principles: While the score has predominantly long slurs on all six notes, in **B 13** the composer preferred two slurs on notes 1 and 2 as well as on notes

3 to 6 if the interval between notes 2 and 3 is a third; occasionally (see, e.g., mm. 76ff.) groups of six notes are slurred in pairs even though the melody moves stepwise.

9a. Quoniam tu solus sanctus

Neither the score nor the corresponding part specifies the octave range of the Corno da caccia; this has led to extensive debates among Bach scholars.³ As far as we know today, no high horns were used for solo parts in the Dresden court orchestra, the ensemble for which the *Missa in B* was conceived. Additionally, the dark timbre of the bass soloist accompanied by two bassoons and continuo makes it more likely for aesthetic reasons that a Corno da caccia *in D basso* was intended. The lack of dynamic indications in the horn part (as opposed to the bassoon parts) does not mean that the part is to be played *forte* throughout.

9b. Cum Sancto Spiritu

This movement immediately follows 9a. *Quoniam tu solus sanctus* in the score. Bach used the staves for the horn and bassoon parts from the previous movement for sopranos I, II and the alto in the subsequent "Cum Sancto Spiritu"; he therefore wrote the final note in the wind parts in the score as eighth notes with fermatas. The edition follows the readings of the parts, which are more precise.

The preceding "Quoniam" is the only movement with two (obligato) bassoon parts. The indication "due Bassoni in unisono" in the bassoon part **B 15** at the beginning of 9b. *Cum Sancto Spiritu* makes us assume that two bassoons played in unison in all other movements, too.

The use of flutes is not specified in the score at the beginning of the movement; according to Bach's habits their use was clearly intended since opening and final movements of large vocal pieces typically make use of the same scoring. Only from m. 238 on the flutes have systems of their own (with the indication "Traversieri"). Bach added the words "Fine S. D. Gl." [Fine Soli Deo Gloria] at the end of the movement, which originally formed the final movement of the *Missa in B* of 1733.

II. Symbolum Nicenum

For the movements from 10. *Credo in unum Deum* onwards, the autograph score **A** is the most authoritative source. As has been described in the Foreword, the two early manuscript copies **C** and **D** need to be consulted to reverse changes made by Carl Philipp Emanuel Bach relating to a performance of the Credo (movements 10–17) in 1786.

10. Credo in unum Deum

Despite the *alla breve* notation, no short bar lines are found in the middle of each measure. The opening measures contain continuo figuration which was apparently copied from Bach's model (see the Individual Remarks).

11. Patrem omnipotentem

No particularities to report.

12. Et in unum Dominum

The score is notated with accolades of six staves; the use of the oboes was indicated by Bach by means of designations such as

³ For the discussion and the organological evidence see *Johann Sebastian Bach, Frühfassungen zur h-Moll-Messe. Kritischer Bericht*, NBA II/1a, ed. Uwe Wolf, Kassel, 2005, pp. 28–30.

“Violin solo,” “Soli” and “Tutti.” Some, but not all of these indications were later erased by Carl Philipp Emanuel Bach and can hardly be detected anymore. The violin parts only occasionally go below the range of the Baroque oboe; it is not necessary to prescribe oboi d’amore. It seems more likely that Bach would have made a pragmatic adjustment if he had written out or revised a set of performance parts. In the edition, the individual oboe parts contain editorial suggestions for Ob II in the respective measures.

13. Et incarnatus est
No particularities to report.

14. Crucifixus
The notation of the “portato” slurs in the bass part is not entirely consistent. For the edition it has been assumed that “portato” slurs are meant to cover each individual measure, though occasionally Bach does not place slurs at all or uses slurs on notes 3 to 6 only if the first two notes have a different pitch than the following ones.

15. Et resurrexit
The use of Fl II is indicated only from m. 8 on (after page turn); in the edition the principle apparent from m. 14 onwards is also adapted in the opening measures.

16. Et in Spiritum Sanctum
With respect to the length of slurs, the notation is somewhat imprecise in the score; in cases of doubt it has been assumed for the edition that longer slurs (typically on three eighth notes in the same direction, unless the group begins or ends with a tied note) are preferred to shorter ones. The isolated slur in m. 8 (Bc) seems to indicate that Bach, contrary to his habits, intended slurs extending on three eighth notes even when octave leaps were involved. For the 1786 performance Carl Philipp Emanuel Bach added numerous ornaments, slurs and articulation marks. The indication “Auch ohne Hob. mit 2 Viol.” (“also without oboes, with two violins”) in **A** shows that, for this performance, the Hamburg Bach replaced the then uncommon oboi d’amore with two solo violins.

17a. Confiteor–17b. Et expecto
At the beginning of the movement there are no indications for the use of instruments. Since the instruments enter in m. 147 after several notated rests without their staves bearing labels, it seems likely that 17a. *Confiteor* and the beginning of 17b. *Et expecto* were indeed intended to be a *cappella*, i.e., without *colla parte* instruments. Further, in a five-part setting it is not self-evident which instruments would have doubled which parts, so that a specification would have been needed.

III. Sanctus

18a. Sanctus
In the opening sections the notation of the score suggest that dotted rhythms (♩.) should be adapted in a 2:1 ratio to the triplets. Furthermore the slurs in Tr I, Tr II in mm. 1–3 suggest that triplets should be slurred consistently, which was the practice at least until 1760.⁴ The movement is the only one that requires three oboes instead of two; in the eighteenth century most likely another player of woodwinds, e.g., flutist, would have realized this part.

18b. Pleni sunt coeli
No particularities to report.

IV. Osanna, Benedictus, Agnus Dei et Dona nobis pacem

19. Osanna in excelsis
Bach treats the last syllable of “Osanna” and the syllable “in” usually as a unit. Whether this principle of “sinelefe” indicates an Italian pronunciation of the Latin text cannot be determined.

20. Benedictus
The solo instrument is not identified in the score; the comparatively high tessitura and the assumption that a contrast is intended between 20. *Benedictus* and 22. *Agnus Dei* make it more likely that the part is conceived for a transverse flute than a violin. The isolated use of *d#1* as an unstressed neighboring note in m. 38 does not contradict the use of a transverse flute. The notation of the score is fairly consistent in that groups of triplets should be slurred, whereas tied notes should not be slurred to the following notes of shorter note value.

21. Osanna repetatur
The movement is not written out in the original score.

22. Agnus Dei
No particularities to report.

23. Dona nobis pacem
The movement is based on 6. *Gratias agimus tibi*. Unlike this movement, the instruments are written out, except that the bassoons are not mentioned by name and have no extra staff. In the edition, a bassoon part has been supplied editorially in analogy to 6. *Gratias agimus tibi* which – as in the original set of parts for the *Missa* – corresponds to the vocal bass part rather than the continuo; short bar lines have been placed in the middle of each measure, although these are not found in the score.

⁴ In the model source, the Sanctus BWV 232^{III}, slurs have also been applied to most of the pairs of dotted notes in the original set of parts (Staatsbibliothek zu Berlin – Preussischer Kulturbesitz, shelf-mark *Mus. ms. Bach St 117*).

Kritischer Bericht

I. Die Quellen

A. Autographe Partitur

Staatsbibliothek zu Berlin – Preußischer Kulturbesitz, Signatur: *Mus. ms. Bach P 180*

Die autographe Partitur besteht aus vier Teilen mit jeweils eigener Titelseite (offensichtlich Überreste von Umschlägen, in die die einzelnen Teile eingelegt waren). Die Handschrift umfasst insgesamt 99 Blätter, darunter 4 Titelblätter, in Hochformat unterschiedlicher Größe (ca. 35–36 x 21,5–23 cm). Seit einer Restaurierung im Jahre 2002 ist die Handschrift nicht mehr gebunden, und die einzelnen Blätter und Doppelblätter werden in mehreren Mappen in einer Box aufbewahrt. Im Zuge der Restaurierung wurden verschiedene Einzelblätter in Teil 2, *Symbolum Nicenum*, wieder zu Doppelblättern zusammengesetzt, aber offenbar anders als im ursprünglichen Zustand.¹

Es gibt mehrere Faksimile-Ausgaben der autographen Partitur:

1. *Johann Sebastian Bach, Messe in h-Moll, Faksimile-Ausgabe nach dem im Besitz der Preuß. Staats-Bibliothek befindlichen Original*, Leipzig: Insel-Verlag 1924.

2. *Johann Sebastian Bach, Messe in h-Moll, Faksimile-Lichtdruck des Autographs*, hrsg. von Alfred Dürr, Kassel u.a.: Bärenreiter 1965 / Leipzig: Deutscher Verlag für Musik² 1983.

3. *Johann Sebastian Bach, Messe in h-Moll BWV 232 mit Sanctus in D-Dur (1724) BWV 232^{III}*, hrsg. von Christoph Wolff, Kassel u.a. 2007.

Die Gesamthandschrift ist wie folgt überliefert: Johann Sebastian Bachs Nachlass, Leipzig – Carl Philipp Emanuel Bach, Berlin und Hamburg (1750) – Johanna Maria Bach, Hamburg (1788) – Anna Carolina Philippina Bach, Hamburg (1795) – Christian Friedrich Gottlob Schwencke, Hamburg (1805) – Hans Georg Nägeli, Zürich (1805) – Hermann Nägeli, Zürich (1836) – Arnold Wehner, Hannover (1857) – Friedrich Chryander, Hamburg (1857), im Auftrag der Bach-Gesellschaft Leipzig – Königliche Bibliothek Berlin (1861).

Die einzelnen Abschnitte umfassen:

1) Kyrie und Gloria (Sätze 1–9)

48 Blätter (Wasserzeichen: Monogramm „AM“ oder „MA“; vgl. NBA IX/1, Nr. 121), paginiert von „[1]“ bis „95“ (die Seitenzählung ab S. 4 in Bachs eigener Hand), die letzte Seite wurde später als „[96]“ gezählt und ist unbeschrieben. Die autographe Titelseite, die diesem Teil vorangestellt ist, wurde von Bach erst um oder nach 1748 hinzugefügt (Wasserzeichen: Kelch, Monogramm „IPF“; vgl. NBA IX/1, Nr. 100) und trägt die Beschriftung: „No. I. | Missa. | a | 5 Voci. | 2 Soprani | Alto | Tenore | Basso. | 3 Trombe | Tamburi | 2 Traverser | 2 Oboi. | 2 Violini | 1 Viola | e | Continuo | di | J. S. Bac[h.]“; der Kopftitel auf S. 1 lautet: „J. J. Missa. à 5. Voci. 6 Stromenti e Continuo di J. S. Bach“ . (Der Name des Komponisten ist stark beschädigt.)

2) Credo (Sätze 10–17)

29 Blätter (Wasserzeichen: Heraldische Lilie, Monogramm „VO“; vgl. NBA IX/1, Nr. 73), paginiert „97“–„152“. Auf S. 152 folgen

zwei Seiten, von denen die erste nur rastriert und die zweite unbeschrieben ist; diese wurden erst nachträglich als „[152a]“ und „[152b]“ gezählt. Die autographe Titelseite (Wasserzeichen: NBA IX/1, Nr. 100; s.o.) vor diesem Teil lautet: „No. 2 | Symbolum Nicenum | à | 5 Voci. | 2 Soprani. | 1 Alto | 1 Tenore. | 1 Basso. | 3 Trombe | Tamburi | 2 Traverser [von JSB geändert zu „2 Traversieri“, später von CPEB verändert in „2 Fl. Traversieri“] | 2 Oboi. | 2 Violini | 1 Viola | e | Continuo. | di | J. S. Bach.“ Die Seiten 111/112 bildeten ein Einzelblatt, auf dem 13. *Et incarnatus est* als Nachtrag hinzugefügt wurde; die Seiten 151/152 enthalten die neuen Vokalstimmen der endgültigen Fassung von 12. *Et in unum Dominum* mit dem Kopftitel „Duo Voces Articuli 2“.

3) Sanctus (Satz 18)

8 Blätter (Wasserzeichen: NBA IX/1, Nr. 73; s.o.), paginiert „153“–„168“. Die autographe Titelseite (Wasserzeichen: NBA IX/1, Nr. 100; s.o.) für diesen Teil lautet: „No. 3. | Sanctus. | a 6 Vocibus [abgekürzt] | 2 Soprani | 2 Alt | 1 Tenor | 1 Bass. | 3 Trombe | Tamburi. | 3 Oboi. | 2 Violini | 1 Viola | e | Continuo. | di | J. S. Bach.“ Der Kopftitel auf S. 153 lautet: „Sanctus. à 6. Voci. 3 Trombe, Tamburi, 3 Oboi. 2 Violini, Viola | e Continuo.“

4) Osanna, Benedictus, Agnus Dei, Dona nobis pacem (Sätze 19–23)
10 Blätter (Wasserzeichen: NBA IX/1, Nr. 73; s.o.), paginiert „169“–„188“. Die autographe Titelseite (Wasserzeichen: NBA IX/1, Nr. 100; s.o.) für diesen Teil lautet: „No. 4. | Osanna, | Benedictus, | Agnus Dei et | Dona nobis pacem. | ab | 8 Vocibus [abgekürzt] | 2 Soprani | 2 Alt | 2 Tenor | 2 Bassi. | 3 Trombe | Tamburi. | 2 Traversieri | 2 Oboi | 2 Violini | 1 Viola | e | Continuo | di | J. S. Bach.“ Der Kopftitel auf S. 169 lautet: „J. J. Osanna in excelsis. ab 8 Voci. 3 Trombe. Tamburi. 2 Trav. 2 Hautb. | 2 Violini, Viola e Continuo.“

B. Originalstimmensatz

Staats- und Universitätsbibliothek – Sächsische Landesbibliothek Dresden, Signatur: *Mus. 2405-D-21*

Der Stimmensatz besteht aus 21 Einzelstimmen (Format: 37,4 x 25,4 cm; Wasserzeichen: Lilie in Wappenschild, Buchstaben „ICV“; vgl. NBA IX/1, Nr. 77). Der originale Umschlag (Format: 37 x 25,5 cm; Wasserzeichen: Lilie in Wappenschild mit Buchstaben „ICH“ und Gegenmarke „KB“; vgl. NBA IX/1, Nachtrag 1) wurde von Kopistenhand beschriftet²: „Gegen | S. Königl. Hoheit und | Churfürstl. Durchl. zu | Sachsen | bezeigte | mit inliegender | Missa | à | 18 | 2. Soprani | Alto | Tenore | Basso | 3. Trombe | Tympali | 1 Corne

¹ Gemeinsam mit der Partitur ist ein unbeschriebenes Blatt (Wasserzeichen: „D & C | B“) überliefert. Die ursprüngliche Position im Band kann nicht mehr bestimmt werden. Das weitverbreitete niederländische Wasserzeichen lässt es möglich erscheinen, dass das Blatt überhaupt erst durch Carl Philipp Emanuel Bach in Hamburg dem Partiturautograph hinzugefügt wurde.

² Der Schreiber konnte als Gottfried Rausch (gest. 1752) identifiziert werden, einem Schreiber der Rats-Kommissionsstube in Dresden, der auch in Bachs Auftrag das Widmungsschreiben vom 27. Juli 1733 aufgesetzt hat.

du Chasse | 2 Traversières | 2 Hautbois | 2 Bassoni | Violoncello | e | Continuo“; Bach fügte darunter die Worte „seine unterthänigste Devotion | der Autor | J. S. Bach“ hinzu.

Zu einem späteren Zeitpunkt wurde die Beschriftung teilweise korrigiert in „à 21.“, und die Angabe „3 Violini“ (korrigiert aus „2 Violini“) wurde zwischen die Zahl der Stimmen und die Angabe „2. Soprani“ eingefügt. Auch nach dieser Korrektur ist die Beschreibung des Stimmensatzes nicht ganz korrekt: Die Violastimme wird überhaupt nicht erwähnt und die zwei Fagotte sind zusammen in einer Stimme notiert.

Faksimileausgabe: *Johann Sebastian Bach, Missa h-Moll BWV 232! Faksimile nach dem Originalstimmensatz der Sächsischen Landesbibliothek*, hrsg. von Hans-Joachim Schulze, Leipzig: Zentralantiquariat der Deutschen Demokratischen Republik/Stuttgart-Neuhausen: Hänssler 1983.

Der Stimmensatz besteht aus den folgenden Einzelstimmen:

- B 1** „Soprano. I.“ (6 Blätter; Bl. 5v–6v unbeschrieben); Schreiber: Carl Philipp Emanuel Bach (Bl. 1–4), J. S. Bach (Bl. 5r)
- B 2** „Soprano. II“ (4 Blätter; Bl. 4v nur rastriert); Schreiber: C. P. E. Bach (bis Nr. 9b, T. 222a), J. S. Bach (Nr. 9b, T. 222bff.)
- B 3** „Alto.“ (4 Blätter; Bl. 4v nur rastriert); Schreiber: J. S. Bach
- B 4** „Tenore.“ (4 Blätter); Schreiber: J. S. Bach
- B 5** „Basso.“ (4 Blätter; Bl. 4v nur rastriert); Schreiber: J. S. Bach
- B 6** „Clarino 1.“ (1 Bl.), Schreiber: J. S. Bach
- B 7** „Clarino 2.“ (1 Bl.); Schreiber: J. S. Bach
- B 8** „Principale“ (1 Bl.); Schreiber: J. S. Bach
- B 9** „Tympana.“ (1 Bl.); Schreiber: J. S. Bach
- B 10** „Corne da Caccia. I ad Quoniam tu solus. [abgekürzt]“ (1 Bl.; Rückseite nur rastriert); Schreiber: J. S. Bach
- B 11** „Traversiere 1“ (4 Blätter; Bl. 4v nur rastriert); Schreiber: J. S. Bach
- B 12** „Traversiere 2“ (4 Blätter; Bl. 4r–v nur rastriert); Schreiber: J. S. Bach
- B 13** „Hautbois 1. [erweitert zu „d’Amour“]“ (4 Blätter; Bl. 4v nur rastriert); Schreiber: unbekannt³ (bis Satz 5, T. 64a), J. S. Bach (ab Satz 5, T. 64b)
- B 14** „Hautbois d’Amour. 2.“ (4 Blätter; Bl. 3v–4v nur rastriert); Schreiber: derselbe unbekannt Kopist wie **B 13** (bis Satz 5, T. 51), J. S. Bach (ab Satz 5, T. 52)
- B 15** „Basson.“ (4 Blätter; Bl. 4v nur rastriert); Schreiber: J. S. Bach
- B 16** „Violino 1.“ (6 Blätter; Bl. 6r–v nur rastriert); Schreiber: J. S. Bach
- B 17** „Violino 1.“, Dublette (5 Blätter); Schreiber: Wilhelm Friedemann Bach (außer der Stimmenbezeichnung von J. S. Bachs Hand)
- B 18** „Violino 2“ (6 Blätter; Bl. 6r–v unbeschrieben); Schreiber: J. S. Bach
- B 19** „Viola“ (4 Blätter); Schreiber: J. S. Bach
- B 20** „Violoncello.“ (6 Blätter); Schreiber: Anna Magdalena Bach (Musik), J. S. Bach (Buchstabenschrift)
- B 21** „Continuo.“ (6 Blätter; untransponiert, mit Bezifferung); Schreiber: derselbe unbekannt Kopist wie **B 13**, **B 14** (Bl. 1–5), J. S. Bach (Bezifferung und Bl. 6)

C. Abschrift Hering

Staatsbibliothek zu Berlin – Preußischer Kulturbesitz, Signatur: *Mus. ms. Bach P 572, P 23 und P 14*

Vollständige Partiturabschrift überwiegend in der Hand des Berliner Musikers Johann Friedrich Hering, um 1765, aus dessen priva-

ter Notensammlung; ein unbekannter Schreiber aus Herings Umfeld trug den Text ein, Carl Philipp Emanuel Bach nahm Korrekturen vor, vor allem in Bd. 2. Da dieser Band ein größeres Format aufweist, wurde die Zusammengehörigkeit der drei Bände nicht gleich erkannt, als sie um das Jahr 1851 mit der Sammlung Voß-Buch in die Königliche Bibliothek Berlin kamen.

Die Handschrift besteht aus drei Einzelbänden:

1) Kyrie und Gloria (Sätze 1–9) = *Mus. ms. Bach P 572*

Die Handschrift umfasst 48 Blätter (Format: 37,5 x 24,5 cm; ohne Wasserzeichen) und eine separate Titelseite in Herings Hand mit der Aufschrift: „Nö: 1. | MISSA. | à | 5. Voci | 2. Soprani | Alto | Tenore | Basso | 3. Trombe | Tamburi | 2. Traversi | 2. Oboi | 2. Violini | 1. Viola | e | Continuo. | di | Sign: J. S. Bach.“ Die Notenseiten sind von „1“ bis „95“ paginiert (letzte Seite unbeschrieben und unpaginiert).

2) Credo (Sätze 10–17) = *Mus. ms. Bach P 23*

Dieser Teil des Manuskripts umfasst 27 Blätter (Format: 43 x 26,5 cm; Wasserzeichen: bekrönter Schild, mit undeutlichen Buchstaben im Schild), die Notenseiten sind von „96“ bis „148“ paginiert (d.h. die Vorderseite jedes Blattes weist eine gerade Seitenzahl auf), letzte Seite unbeschrieben und unpaginiert. Die Titelseite für diesen Teil lautet: „Nö: 2. | Symbolum Nicenum | à | 5. Voci | 2. Soprani | 1. Alto | 1. Tenore | 1. Basso. | 3 Trombe | Tamburi | 2. Traversi | 2. Oboi | 2. Violini | 1. Viola | è | Continuo | di | J. S. Bach.“

3) Sanctus–Dona nobis pacem (Sätze 18–23) = *Mus. ms. Bach P 14*
Dieser Band besteht aus zwei Teilen, die in einen Band zusammengebunden sind.

3a) Sanctus (Satz 18)

8 Blätter und eine separate Titelseite (Format: 37,5 x 24 cm, ohne Wasserzeichen; vgl. Bd. 1); die Notenseiten sind paginiert von „149“ bis „164“, hierauf folgt ein unbeschriebenes und ungezähltes Blatt. Die Titelseite für diesen Teil lautet: „Nö: 3. | Sanctus. | a 6. Vocibus. [abgekürzt] | 2. Soprani | 2. Alti | 1. Tenor | 1. Bass. | 3. Trombe | Tamburi | 3. Oboi | 2. Violini | 1. Viola | e | Continuo | di | J. S. Bach.“

3b) Osanna, Benedictus, Agnus Dei, Dona nobis pacem (Sätze 19–23)

10 Blätter und eine separate Titelseite (Format: 37,5 x 24 cm, ohne Wasserzeichen; vgl. Bd. 1); die Notenseiten sind von „165“ bis „184“ paginiert, hierauf folgt ein unbeschriebenes und ungezähltes Blatt. Die Titelseite für diesen Teil lautet: „No: 4. | Osanna | Benedictus | Agnus Dei et | Dona nobis pacem | ab | 8. Vocibus | 2. Soprani | 2. Alti | 2. Tenori | 2. Bassi | 3. Trombe | Tamburi | 2. Traversieri | 2. Oboi | 2. Violini | 1. Viola | e | Continuo | di | J. S. Bach.“

D. Abschrift Kirnberger

Staatsbibliothek zu Berlin – Preußischer Kulturbesitz, Signatur: *Am.B. 3*

Vollständige Partiturabschrift von der Hand des Berliner Kopisten Anon. 402, um 1769⁴, aus der privaten Notensammlung des Berliner Musikers und Bach-Schülers Johann Philipp Kirnberger.

³ Der Schreiber ist bislang nur in dieser Handschrift nachgewiesen. Alfred Dürr bezeichnete ihn als „Anon. 20“, er wird in NBA IX/3 als „L 77“ geführt.

⁴ Das Vorsatzblatt beider Bände weist ein Wasserzeichen mit der Jahreszahl „1769“ auf.

Das Manuskript besteht aus zwei Einzelbänden:

1) Kyrie und Gloria (Sätze 1–9)

Bd. 1 umfasst 84 Bl. (Format: 36,5 x 22,5 cm; Wasserzeichen: Bruchstücke von Buchstaben). Die Titelseite für diesen Teil lautet: „Missa I a | 5 Voci. | 2 Soprani. | Alto. | Tenore. | Basso. | 3 Trombe | Tamburi. | 2 Traversi. | 2 Oboi. | 2 Violini. | 1 Viola | e | Continuo.“ Der Komponistname steht nur auf dem vorderen Einband, der die Aufschrift „Missa I von | Joh: Sebast: Bach | erster Teil.“ trägt. Die Angabe „Nro 1.“ findet sich in der rechten oberen Ecke der Titelseite.

2) Credo–Dona nobis pacem (Sätze 10–23)

Bd. 2 umfasst 95 Bl. (Format: 36,5 x 22,5 cm; Wasserzeichen: Bruchstücke von Buchstaben). Die Titelseite dieses Teils lautet nur „Nro 2.“ in der rechten oberen Ecke; die Seite ist sonst leer. Der Komponistname kann nur dem Einband mit der Aufschrift „Missa I von | Joh: Sebast: Bach | zweiter Teil.“ entnommen werden.

Provenienz des Gesamtmanuskripts: Johann Philipp Kirnberger (Besitzermerk auf Bl. 1r) – Anna Amalia von Preußen (wohl 1783) – Joachimsthalsches Gymnasium (1787) – Königliche Bibliothek Berlin (1914).

II. Zur Edition

Die Stuttgarter Bach-Ausgaben verstehen sich als kritische Ausgaben. Der Notentext wird unter Berücksichtigung des aktuellen Forschungsstandes durch einen kritischen Vergleich der erreichbaren Quellen gewonnen. Die Textredaktion orientiert sich an den Editionsrichtlinien, wie sie für die Denkmälerausgaben und Gesamtausgaben unserer Zeit entwickelt wurden. Instrumentenangaben und Satztitel werden vereinheitlicht. Die Einzelsätze sind in den Quellen nicht nummeriert.

Alle Eingriffe des Herausgebers in den Notentext, die über die Anpassung an moderne Notationsgewohnheiten – etwa die Ersetzung heute ungebräuchlicher Schlüssel oder die Akzidentiensetzung – hinausgehen, werden in geeigneter Weise dokumentiert. Manche Entscheidungen, etwa die Ergänzung von im Original fehlenden dynamischen Bezeichnungen, Staccatopunkten oder Bögen, können bereits im Notentext durch Kleinstich, Kursivdruck, Strichelung oder auch Klammern gekennzeichnet werden und bedürfen im Kritischen Bericht keiner gesonderten Erwähnung. Angaben zu Artikulation und Dynamik wurden vom Herausgeber nur mit großer Zurückhaltung hinzugefügt. Bögen oder andere Artikulationszeichen wurden in erster Linie innerhalb einer Instrumentengruppe (z.B. Blechbläser, Flöten, Oboen, Streicher) bei Stimmen, die gleichzeitig erklingen, hinzugefügt. Anpassungen zwischen diesen Instrumentengruppen wurden nur vorgenommen, wenn Bögen in der Mehrzahl der Stimmen mit denselben Tönen oder mit sehr ähnlicher Melodieführung anzutreffen sind.

In den Einzelanmerkungen werden alle Abweichungen der Edition von den Quellen sowie wesentliche Unterschiede zwischen den Quellen festgehalten. Die Verwendung von interaktiven Präsentationsformen in EDIROM macht es möglich, die gedruckten Einzelanmerkungen auf diejenigen Varianten zu beschränken, die für ein Verständnis des Notentexts und für seine klangliche Realisierung wichtig sind. In den gedruckten Einzelanmerkungen werden deshalb keine Informationen zu folgenden Aspekten angegeben:

- Vorzeichen, die in einer Stimme fehlen, wenn die gemeinte Tonhöhe zweifelsfrei feststeht (z.B. wenn ein Vorzeichen von Bach bei einer oder mehr als einer Stimme gesetzt ist, aber in einer

dritten Stimme fehlt, obwohl sie im Wesentlichen den gleichen Inhalt aufweist).

- Angaben zu Artikulation und Dynamik, die Bach nur in den Originalstimmensatz **B** eingetragen hat, die aber nicht in der autographen Partitur **A** stehen, sowie umgekehrt auch die vereinzelt Artikulationsbögen, die in den Sätzen 1. *Kyrie I–9b. Cum Sancto Spiritu* nur in **A** anzutreffen sind.
- „Fehlende“ Vorzeichen in der Bezifferung.
- Autographe Korrekturen in **A** als Teil des Kompositionsprozesses (wohingegen über spätere Änderungen regelmäßig berichtet wird, soweit es sich nicht nur um Verdeutlichungen handelt).
- Akzidenzien und Warnungsakzidenzien, die durch Bachs Notationsgewohnheiten, nach denen eine Alterierung nicht für den gesamten Takt, sondern nur für die unmittelbar nachfolgenden Noten mit derselben Tonhöhe (dies aber auch über den Taktstrich hinaus) gilt, impliziert sind.

Der lateinische Text ist auf die Bedürfnisse unserer Zeit in Bezug auf Rechtschreibung, Zeichensetzung und Groß-Klein-Schreibung angepasst. Besonderheiten von Bachs Textunterlegung wie Abweichungen vom üblichen liturgischen Text (z.B. „altissime“ statt „altissimus“ oder „gloria ejus“ anstelle von „gloria tua“) wurden beibehalten; die Rechtschreibung wurde nicht modernisiert, wo die Aussprache betroffen sein könnte (beispielsweise Bachs „expecto“ gegenüber modern „exspecto“).

Als Resultat der komplexen Entstehungsgeschichte des Werkes besteht die *Messe in h-Moll* BWV 232 aus zwei separaten Teilen, die mit Blick auf die Editions-methoden unterschiedlich zu behandeln sind. Die autographe Partitur (Quelle **A**) enthält zwar beide Teile, bildet aber nur für den zweiten Teil (10. *Credo–23. Dona nobis pacem*) die Hauptquelle. Für den ersten Teil (1. *Kyrie I–9b. Cum Sancto Spiritu*) dient die Originalpartitur **A** lediglich als Vergleichsquelle, während die Edition auf dem Originalstimmensatz (Quelle **B**) beruht.

In den Einzelanmerkungen wird über folgende Unterschiede zwischen der jeweiligen Hauptquelle und der Edition bzw. den Hauptquellen untereinander berichtet:

- Unterschiede in Tonhöhen und Notenwerten.
- Relevante Unterschiede in der Artikulation, die über die allgemeinen Hinweise zur Aufführungspraxis (S. 284ff.) hinausgehen.
- Für die *Missa* (1. *Kyrie I–9b. Cum Sancto Spiritu*): spätere Änderungen von J. S. Bach, die mit der Revision als erster Teil der *Messe in h-Moll* in Zusammenhang stehen.
- Eintragungen von fremder Hand im Partiturotograph **A**.
- Für das *Symbolum Nicenum* (10. *Credo–17b. Et expecto*): größere Änderungen am Notentext und an der Textunterlegung von Carl Philipp Emanuel Bach im Zusammenhang mit der Aufführung von 1786.

Die zugehörige DVD, die auf EDIROM basiert, liefert zusätzliche Informationen wie z.B. zur Herkunft von Bögen und Vorzeichen, soweit diese nicht in allen Quellen stehen, und ein PDF mit allen Einzelanmerkungen auf Deutsch.

Die Einzelanmerkungen im Band liegen auf Englisch vor (siehe III. Individual Remarks, S. 298ff.)

Critical Report

I. The Sources

A. Autograph Score

Staatsbibliothek zu Berlin – Preussischer Kulturbesitz, shelfmark: *Mus. ms. Bach P 180*

The autograph score consists of four sections with individual title pages (apparently remainders of wrappers for the individual parts). It comprises a total of 99 folios, among them 4 folios with title pages, in upright format of varying sizes (ca. 35–36 x 21.5–23 cms). Since a restauration undertaken in 2002 the MS remains unbound and the individual folios and bi-folios are kept in several folders in a box. During the restauration several individual leaves in part 2, *Symbolum Nicenum*, were recombined to bi-folios, though apparently differently from their original state.¹

There exist several facsimile editions of the autograph score:

1. *Johann Sebastian Bach, Messe in h-Moll, Faksimile-Ausgabe nach dem im Besitz der Preuß. Staats-Bibliothek befindlichen Original*, Leipzig: Insel-Verlag, 1924.

2. *Johann Sebastian Bach, Messe in h-Moll, Faksimile-Lichtdruck des Autographs*, ed. Alfred Dürr, Kassel: Bärenreiter, 1965 / Leipzig: Deutscher Verlag für Musik, 21983.

3. *Johann Sebastian Bach, Messe in h-Moll BWV 232 mit Sanctus in D-Dur (1724) BWV 232^{III}*, ed. Christoph Wolff, Kassel, 2007.

The provenance of the entire MS is: Johann Sebastian Bach's estate, Leipzig – Carl Philipp Emanuel Bach, Berlin and Hamburg (1750) – Johanna Maria Bach, Hamburg (1788) – Anna Carolina Philippina Bach, Hamburg (1795) – Christian Friedrich Gottlob Schwencke, Hamburg (1805) – Hans Georg Naegeli, Zurich (1805) – Hermann Naegeli, Zurich (1836) – Arnold Wehner, Hanover (1857) – Friedrich Chrysander, Hamburg (1857) on behalf of the Bach-Gesellschaft, Leipzig – Königliche Bibliothek, Berlin (1861).

The individual sections comprise:

1) Kyrie and Gloria (Movements 1–9)

48 folios (watermark: monogram “AM” or “MA”; cf. NBA IX/1, No. 121), paginated “[1]”–“95” (the pagination from p. 4 on in Bach's hand), the last page (later paginated “[96]”) is blank. The autograph title page preceding this section which was added by Bach only after c. 1748 (watermark: chalice, monogram “IPF”; cf. NBA IX/1, No. 100) reads: “No. I. | Missa. | a | 5 Voci. | 2 Soprani | Alto | Tenore | Basso. | 3 Trombe | Tamburi | 2 Traverse | 2 Oboi. | 2 Violini | 1 Viola | e | Continuo | di | J. S. Bac[h.]”; the heading on p. 1 reads: “J. J. Missa. à 5. Voci. 6 Stromenti e Continuo di J. S. Bach” (the composer's name being heavily damaged).

2) Credo (Movements 10–17)

29 folios (watermark: heraldic lily, monogram “VO”; cf. NBA IX/1, No. 73), paginated “97”–“152”, after p. 152 two pages (the first with staff lines only, the second blank) follow which originally remained unpaginated. (These have been counted in the mean time as “[152a]” and “[152b]”). The autograph title page (watermark: NBA IX/1, No. 100; see above) preceding this section

reads: “No. 2 | Symbolum Nicenum | à | 5 Voci. | 2 Soprani. | 1 Alto | 1 Tenore. | 1 Basso. | 3 Trombe | Tamburi | 2 Traverse [changed by JSB to „2 Traversieri“, later changed by CPEB to „2 Fl. Traversieri“] | 2 Oboi. | 2 Violini | 1 Viola | e | Continuo. | di | J. S. Bach.” Pp. 111–112 is an individual leaf on which *13. Et incarnatus est* was added as an afterthought; pp. 151–152 contain the new vocal parts for the final revision of *12. Et in unum Dominum* with the heading “Duo Voces Articuli 2.”

3) Sanctus (Movement 18)

8 folios (watermark: NBA IX/1, No. 73; see above), paginated “153”–“168”. The autograph title page (watermark: NBA IX/1, No. 100; see above) for this section reads: “No. 3. | Sanctus. | a 6 Vocibus [abbreviated] | 2 Soprani | 2 Alti | 1 Tenor | 1 Bass. | 3 Trombe | Tamburi. | 3 Oboi. | 2 Violini | 1 Viola | e | Continuo. | di | J. S. Bach.” The heading on p. 153 reads: “Sanctus. à 6. Voci. 3 Trombe, Tamburi, 3 Oboi. 2 Violini, Viola | e Continuo.”

4) Osanna, Benedictus, Agnus Dei, Dona nobis pacem (Movements 19–23)

10 folios (watermark: NBA IX/1, No. 73; see above), paginated “169”–“188”. The autograph title page (watermark: NBA IX/1, No. 100; see above) for this section reads: “No. 4. | Osanna, | Benedictus, | Agnus Dei et | Dona nobis pacem. | ab | 8 Vocibus [abbreviated] | 2 Soprani | 2 Alti | 2 Tenor | 2 Bassi. | 3 Trombe | Tamburi. | 2 Traversieri | 2 Oboi | 2 Violini | 1 Viola | e | Continuo | di | J. S. Bach.” The heading on p. 169 reads: “J. J. Osanna in excelsis. ab 8 Voci. 3 Trombe. Tamburi. 2 Trav. 2 Hautb. | 2 Violini, Viola e Continuo.”

B. Original Set of Parts

Staats- und Universitätsbibliothek – Sächsische Landesbibliothek Dresden, shelfmark: *Mus. 2405-D-21*

The set consists of 21 parts (format: 37.4 x 25.4 cms; watermark: lily in heraldic shield, letters “ICV”; cf. NBA IX/1, No. 77). The original wrapper (format: 37 x 25.5 cms; watermark: lily in heraldic shield with letters “ICH” and countermark “KB”; cf. NBA IX/1, Appendix 1) was written in a copyist's hand²: “Gegen | S. Königl. Hoheit und | Churfürstl. Durchl. zu | Sachßen | bezeugte | mit inliegender | Missa | à 18 | 2. Soprani | Alto | Tenore | Basso | 3. Trombe | Tympali | 1 Corne du Chasse | 2 Traversières | 2 Hautbois | 2 Bassoni | Violoncello | e | Continuo”, to which Bach added “seine unterthänigste Devotion | der Autor | J. S. Bach”. Later the wrapper was partly corrected to “à 21.” and a reference “3 Violini” (corrected from “2 Violini”) was squeezed in between

¹ Together with the score a blank folio (watermark: “D & C I B”) has been preserved. Its original position within the volume can no longer be determined. The common Dutch watermark makes it likely that this sheet had been added by Carl Philipp Emanuel Bach in Hamburg at the earliest to the autograph score of the Mass.

² The scribe has been identified as Gottfried Rausch (d. 1752), copyist of the Rats-Kommissionsstube in Dresden, who also wrote on Bach's behalf the dedicatory letter of 27 July 1733.

the number of parts and "2. Soprani". Despite this correction the description of the set of parts remained incorrect: The viola is not mentioned while the two bassoons are written into one single part book.

Facsimile edition: *Johann Sebastian Bach, Missa h-Moll BWV 232!*. Faksimile nach dem Originalstimmensatz der Sächsischen Landesbibliothek, ed. Hans-Joachim Schulze, Leipzig: Zentralantiquariat der Deutschen Demokratischen Republik/Stuttgart-Neuhausen: Hänssler, 1983.

The set consists of the following parts:

- B 1** "Soprano. I." (6 folios; fol. 5v–6v blank); Scribe: Carl Philipp Emanuel Bach (fols. 1–4), J. S. Bach (fol. 5r)
- B 2** "Soprano. II" (4 folios; fol. 4v staff lines, but no music), Scribe: C. P. E. Bach (up. to no. 9b, m. 222a), J. S. Bach (no. 9b, m. 222b ff.)
- B 3** "Alto." (4 folios; fol. 4v staff lines, but no music); Scribe: J. S. Bach
- B 4** "Tenore." (4 folios); Scribe: J. S. Bach
- B 5** "Basso." (4 folios; fol. 4v staff lines, but no music); Scribe: J. S. Bach
- B 6** "Clarino 1." (1 folio); Scribe: J. S. Bach
- B 7** "Clarino 2." (1 folio); Scribe: J. S. Bach
- B 8** "Principale" (1 folio); Scribe: J. S. Bach
- B 9** "Tympana." (1 folio); Scribe: J. S. Bach
- B 10** "Corne da Caccia. I ad Quoniam tu solus. [abbreviated]" (1 folio; verso staff lines, but no music); Scribe: J. S. Bach
- B 11** "Traversiere 1" (4 folios; fol. 4v staff lines, but no music); Scribe: J. S. Bach
- B 12** "Traversiere 2" (4 folios; fols. 4r–v staff lines, but no music); Scribe: J. S. Bach
- B 13** "Hautbois 1. [expanded to: "d'Amour"]" (4 folios; fol. 4v staff lines, but no music); Scribe: unknown³ (up to movt. 5, m. 64a), J. S. Bach (from movt. 5, m. 64b on)
- B 14** "Hautbois d'Amour. 2." (4 folios; fols. 3v–4v staff lines, but no music); Scribe: same unknown copyist as **B 13** (up to movt. 5, m. 51), J. S. Bach (from movt. 5, m. 52 on)
- B 15** "Basson." (4 folios; fol. 4v staff lines, but no music); Scribe: J. S. Bach
- B 16** "Violino 1." (6 folios; fols. 6r–v staff lines, but no music); Scribe: J. S. Bach
- B 17** "Violino 1.", duplicate copy (5 folios); Scribe: Wilhelm Friedemann Bach (except the heading which is in J. S. Bach's hand)
- B 18** "Violino 2" (6 folios; fols. 6r–v blank); Scribe: J. S. Bach
- B 19** "Viola" (4 folios); Scribe: J. S. Bach
- B 20** "Violoncello." (6 folios); Scribe: Anna Magdalena Bach (music), J. S. Bach (verbal indications)
- B 21** "Continuo." (6 folios; not transposed, with figuration); Scribe: same unknown copyist as **B 13**, **B 14** (fols. 1–5), J. S. Bach (figuration only and fol. 6)

C. Hering Copy

Staatsbibliothek zu Berlin – Preussischer Kulturbesitz, shelfmark: *Mus. ms. Bach P 572, P 23 and P 14*

Complete manuscript score mainly in the hands of the Berlin musician Johann Friedrich Hering, c. 1765, from his personal collection; an unknown copyist from his circle wrote the text, Carl Philipp Emanuel Bach entered corrections, particularly in vol. 2. Since vol. 2 is in a different format, the common bond between

the three volumes was not immediately recognized when the volumes came into the Königliche Bibliothek Berlin in or after 1851 (Voß-Buch collection).

The MS consists of three separate volumes:

1) Kyrie and Gloria (Movements 1–9) = *Mus. ms. Bach P 572*
The manuscript consists of 48 folios (format: 37.5 x 24.5 cms; no watermark) and a separate title page in Hering's hand which reads: "Nö: 1. | MISSA. | à | 5. Voci | 2. Soprani | Alto | Tenore | Basso | 3. Trombe | Tamburi | 2. Traversi | 2. Oboi | 2. Violini | 1. Viola | e | Continuo. | di | Sign: J. S. Bach." The music pages are paginated "1"–"95" (last verso blank and unpaginated).

2) Credo (Movements 10–17) = *Mus. ms. Bach P 23*
This section of the manuscript consists of 27 folios (format: 43 x 26.5 cms; watermark: crowned shield, illegible letters in a shield), the music pages are paginated "96"–"148" (i.e., the recto of each folio bears an even number), last verso blank and unpaginated. The title page for this section reads: "Nö: 2. | Symbolum Nicenum | à | 5. Voci | 2. Soprani | 1. Alto | 1. Tenore | 1. Basso. | 3 Trombe | Tamburi | 2. Traversi | 2. Oboi | 2. Violini | 1. Viola | è | Continuo | di | J. S. Bach."

3) Sanctus–Dona nobis pacem (Movements 18–23) = *Mus. ms. Bach P 14*

This volume consists of two sections which were bound into one single volume.

3a) Sanctus (Movement 18)

8 folios and a separate title page (format: 37.5 x 24 cms, no watermark; cf. vol. 1); the music pages are paginated "149"–"164", followed by a blank und unpaginated folio. The title page for this section reads: "Nö: 3. | Sanctus. | a 6. Vocibus. [abbreviated] | 2. Soprani | 2. Alti | 1. Tenor | 1. Bass. | 3. Trombe | Tamburi | 3. Oboi | 2. Violini | 1. Viola | e | Continuo | di | J. S. Bach."

3b) Osanna, Benedictus, Agnus Dei, Dona nobis pacem (Movements 19–23)

10 folios and a separate title page (format: 37.5 x 24 cms, no watermark; cf. vol. 1); the music pages are paginated "165"–"184", followed by a blank und unpaginated folio. The title page for this section reads: "No: 4. | Osanna | Benedictus | Agnus Dei et | Dona nobis pacem | ab | 8. Vocibus | 2. Soprani | 2. Alti | 2. Tenori | 2. Bassi | 3. Trombe | Tamburi | 2. Traversieri | 2. Oboi | 2. Violini | 1. Viola | e | Continuo | di | J. S. Bach."

D. Kirnberger Copy

Staatsbibliothek zu Berlin – Preussischer Kulturbesitz, shelfmark: *Am.B. 3*

Complete manuscript score in the hands of the Berlin copyist Anon. 402, c. 1769⁴, from the personal collection of the Berlin musician and former student of Johann Sebastian Bach, Johann Philipp Kirnberger.

The MS consists of two separate volumes:

1) Kyrie and Gloria (Movements 1–9)

Vol. 1 consists of 84 fols. (format: 36.5 x 22.5 cms; watermark: fragments of letters). The title page for this section reads: "Missa

³ The scribe has only been documented so far in this MS. He was labeled "Anon. 20" by Alfred Dürr and relabeled as "L 77" in NBA IX/3.

⁴ The flyleaf for each volume bears a watermark with the date "1769."

1 a | 5 Voci. | 2 Soprani. | Alto. | Tenore. | Basso. | 3 Trombe | Tamburi. | 2 Traversi. | 2 Oboi. | 2 Violini. | 1 Viola | e | Continuo.""; the composer's name is only found on the cover of the volume with the inscription: "Missa | von | Joh: Sebast: Bach | erster Teil." The numbering "Nro 1." is found in the upper right corner of the title page.

2) Credo–Dona nobis pacem (Movements 10–23)

Vol. 2 consists of 95 fols. (format: 36.5 x 22.5 cms; watermark: fragments of letters). The title page of this section reads only "Nro 2." in the upper right corner and is otherwise blank. The author's name can be derived from the cover: "Missa | von | Joh: Sebast: Bach | zweiter Teil."

Provenance of the entire MS: Johann Philipp Kirnberger (owner's mark on fol. 1r) – Anna Amalia of Prussia (probably 1783) – Joachimsthalsches Gymnasium (1787) – Königliche Bibliothek, Berlin (1914).

II. On the Edition

The Stuttgarter Bach-Ausgaben (SBA; Stuttgart Bach Editions) are to be understood as critical editions. The musical text is the result of a critical comparison and evaluation of the available sources obtained according to the current state of research. The editorial principles for the musical text are derived from the editorial guidelines developed for scholarly complete works editions and monument series of our time. Instrument indications and movement titles have been standardized. The movements are not numbered in the sources.

All editorial changes to the score that go beyond the application of modern standards of notation – such as the replacement of clefs that are no longer common today or the notation of accidentals – are documented appropriately. Some editorial decisions, such as the addition of dynamic markings missing in the original sources or staccato dots and slurs by obvious analogy, can already be marked in the score through small print, italics, dotted lines, or parentheses, and require thus no separate mention in the Critical Report. The editor has added articulation marks and dynamics very reluctantly. Editorial slurs or other articulation marks have primarily been added within a group of instruments (e.g., brass instruments, flutes, oboes, strings) between parts that sound simultaneously. Adaptations beyond these groups of instruments were made only if slurs are found in the majority of parts with the same pitches or with almost identical melodic patterns.

In the Individual Remarks all deviations of the edition from the sources and significant differences between the sources have been recorded. The use of interactive forms of presentation in EDIROM makes it possible to limit the printed portion of the Critical Report to variants that are relevant for an understanding of the musical text and its phonetic realization. In the printed Individual Remarks, information on the following aspects is therefore not provided:

- Accidentals missing in a specific part if the intended pitch is apparent without any doubt (e.g., when an accidental is entered by Bach into one or more than one part, but lacks in a third part with basically the same content).
- Articulation marks and dynamics that Bach entered only in the original set of parts **B**, but which are not found in the autograph score **A** and, conversely, separate slurs which in the movements *1. Kyrie I–9b. Cum Sancto Spiritu* are found only in **A**.
- "Missing" accidentals in the figuration.

- Autograph corrections in **A** as part of the compositional process, while later changes that go beyond mere clarifications have regularly been reported.
- Accidentals and cautionary accidentals which are implicit according to Bach's notational habits where an alteration does not carry on for the entire measure, but applies only to subsequent notes with the same pitch (even beyond barlines).

The Latin text is adapted to the needs of our time with respect to orthography, capitalization and punctuation. Idiosyncrasies of Bach's text underlay such as deviations from the common liturgical text (e.g., "altissime" instead of "altissimus" or "gloria ejus" instead of "gloria tua") have been maintained and the spelling has not been modernized where it might affect pronunciation, (e.g., Bach's "expecto" versus "exspecto").

As a result of the complex genesis of the work, the *Mass in B Minor* BWV 232 consists of two separate parts which need to be treated separately with respect to the editorial method. The autograph score (source **A**) contains both parts, but it serves as the main source for the second part (*10. Credo–23. Dona nobis pacem*) only; for the first part (*1. Kyrie I–9b. Cum Sancto Spiritu*) the autograph score **A** serves as a source for comparison, while the edition itself is based on the original set of parts (source **B**).

In the Individual Remarks the following variants between the respective main source and the edition or between the main sources themselves have been reported:

- Differences in pitches and note values.
- Relevant differences in the articulation that go beyond the general issues of notation (pp. 288ff.).
- For the *Missa (1. Kyrie I–9b. Cum Sancto Spiritu)*, later changes by J. S. Bach that relate to the revision as the first part of the *Mass in B Minor*.
- Entries in another hand in the autograph score **A**.
- For the *Symbolum Nicenum (10. Credo–17b. Et expecto)*, major changes to pitches and text underlay by Carl Philipp Emanuel Bach relating to the performance of 1786.

The accompanying DVD, based on EDIROM, provides additional information, such as the origin of slurs and accidentals if they are not found in all of the sources, and a PDF with all Individual Remarks in German.

III. Individual Remarks

Abbreviations: CPEB = Carl Philipp Emanuel Bach, JCFB = Johann Christoph Friedrich Bach, JSB = Johann Sebastian Bach, SBA = Stuttgarter Bach-Ausgabe.

A = Alto, B = Basso, Bc = Continuo, Cor = Corno da caccia, Fg = Fagotto, Fl I, II = Flauto traverso, m./mm. = measure(s), Ob I, II = Oboe, Obda I, II = Oboe d'amore, S I, II = Soprano, T = Tenore, Timp = Timpani, Tr = Tromba, Va = Viola, VI I, II = Violino.

References are given in the following order: Measure – part, sign within the measure (note or rest; grace notes are not counted) – Source: Reading/Remarks. The counting of measures and signs always refers to the present edition.

1. Kyrie I

The autograph score **A** has no tempo marking in m. 1, but “largo” is found in m. 5 (notated at the system Bc). The decision to use flutes in this movement is apparently an afterthought as can be derived from the position of the entries “Traverse I e” at staff 1 and 2 in **A**. The range of the oboe part is below the Baroque's instrument compass e.g. Ob II, m. 12. Therefore Bach apparently instructed the copyist to realize this movement with 2 Obda in the original set of parts (source **B**). Since Obda is a transposing instrument, the parts were transposed to D minor by simply using French violin clefs (g^1 on the first line of the staff) and the key signature for D minor. Since the autograph score is notated at pitch (as are later occurrences of Obda in **B 13**, see, e.g., the autograph entry for 8. *Qui sedes*), SBA does not transpose the respective parts. The numerous accidental errors in these parts have not been reported. The word “eleison” is sometimes used as a word with three syllables, sometimes with four syllables. In cases of doubt SBA follows the division of syllables suggested by the beaming.

1	Bc	B 20: “molt' adagio”
5	VI I, VI II, Va	B 16, B 18, B 19: “Largo è un poco piano”
19	Fl I, II	A: with slur on 19/8–20/1
19	Obda I	B 13: with slur on 19/8–20/1
20	Obda I, II	B 14: with slur on 4–5
23	Bc 10	B 21: fig. $\frac{7}{5}$ instead of $\frac{6}{4}$ _[4±]
41	Bc 2	B 21: fig. $\frac{5}{4}$ instead of $\frac{3}{3}$ ⁺
55	Bc 5	B 21: fig. $\frac{6}{2}$ ⁺ instead of $\frac{6}{4}$ ⁺
62	Bc 3	B 21: fig. $\frac{6}{2}$ ⁺ instead of $\frac{6}{4}$ ⁺
64	S II 3	B 2: \downarrow instead of \downarrow ; but cf. VI I
83	Bc 4	B 21: fig. $\frac{6}{2}$ ⁺ instead of $\frac{6}{4}$ ⁺
88	Bc 4	B 21: fig. $\frac{6}{4}$ instead of $\frac{6}{3}$
101	Bc 2	B 21: fig. $\frac{6}{2}$ ⁺ instead of $\frac{6}{4}$ ⁺
116	Bc 3	B 21: fig. $\frac{6}{2}$ ⁺ instead of $\frac{6}{4}$ ⁺
124	VI II 6–7	A: a-b instead of a^1-b^1

2. Christe eleison

The violin part is notated in soprano clef to avoid ledger lines; in **A** corrected from violin clef and labeled “Violini I unisoni”.

22	Bc 1–2	B 21: fig. $\frac{6}{8}$ [±] instead of $\frac{5}{7}$ [±]
49	Bc 1	B 21: fig. $\frac{6}{8}$ instead of $\frac{7}{5}$ [±]
66	S II 2–3	A: with slur

3. Kyrie II

The autograph score (**A**) of this movement is notated on five staves; the upper staff is labeled “Soprano 1 et I 2. in unis.,” the second staff is labeled “Alto,” the other staves have no designation. The Obda parts **B 13** and **B 14** are transposed by use of French violin clefs and a different key signature; cf. 1. *Kyrie I*. Missing slurs in *colla parte* instruments are not listed.

8	B 1	A: text underlay “le” not until note 5
12	A 6	A, B 14, B 18: $c\sharp^7$ instead of $b\sharp$
36	Bc 7	B 21: fig. 6 instead of 5+
45	Bc 3	B 21: fig. $\frac{7}{5}$ instead of $\frac{6}{4}$
47–50	Fg	B 15: follows Bc, not B (copying error)

4a. Gloria in excelsis Deo

This movement – together with 7a. *Domine Deus* and 9b. *Cum Sancto Spiritu* – was revised by Bach in BWV 191 *Gloria in excelsis Deo*, apparently an occasional music to be performed at the university church (Paulinerkirche) on 25 December 1742.⁵ Some of the later revisions in these movements in **A** apparently relate to this performance.

Later revisions in **A**
61–64 **A**



1	–	“Vivace” in B 16, B 17, B 20 only
48	S I 4–5	A: with slur
59	Bc 1–2	B 21: fig. 9 8 instead of 8
60	Bc 3	B 21: fig. 5+ instead of 5±

4b. Et in terra pax

Later revisions in **A**



122ff. Coro
When revising the autograph score **A** Bach changed the declamation of “hominibus” from $\text{mi} \cdot \text{ni} \cdot \text{bus}$ to $\text{mi} \cdot \text{ni} \cdot \text{bus}$ in the following instances [part (m.)]: S I (m. 122), S II (mm. 136, 175), A (m. 125), T (m. 129), B (m. 132), but overlooked doing so in some parallel instances: S I (m. 144), A (mm. 148, 171), T (m. 151), B (m. 155).



104	VI II 6	A: b^1 instead of d^2 (cf. S I)
105	S I	A: text underlay “pax” erroneously repeated at note 6
107	S I 1–2	A: $\text{mi} \cdot \text{ni} \cdot \text{bus}$ instead of $\text{mi} \cdot \text{ni} \cdot \text{bus}$
113	S I	A: lacks text underlay “tis”
117	Ob I 8	B 13: erroneously g^2 instead of a^2
156	A 8	A, B 3: c^2 (with \sharp); SBA adapts to Fl II, Ob II, VI II
157	Bc 7	B 21: fig. $\frac{6}{4}$ instead of $\frac{7}{4}$ [±]
164	A 3	B 3: erroneously $\text{mi} \cdot \text{ni} \cdot \text{bus}$ instead of $\text{mi} \cdot \text{ni} \cdot \text{bus}$

5. Laudamus te

Later revisions in **A**

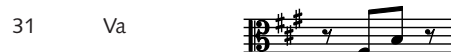

40 S II 3 **A:** with tr ; appoggiatura lacks in **A**



40	Bc 5	B 21: fig. $\frac{5}{5}$ instead of $\frac{5}{5}$
47	Va 7	B 19: erroneously b instead of $c\sharp^7$

⁵ Cf. Markus Rathey, “Zur Entstehungsgeschichte von Bachs Universitätsmusik ‘Gloria in excelsis Deo’ BWV 191,” in: *Bach-Jahrbuch* 99 (2013), pp. 319–328.

6. Gratias agimus tibi

This movement originates from movement 2 "Wir danken dir, Gott, wir danken dir" of the cantata with the same title BWV 29 (1731). For the later reuse as the final movement of the *Mass in B minor* see below, 23. *Dona nobis pacem*.

Later revisions in A

19f. T  - bi, gra - ti - as a - gi - mus ti - bi

32 B  - pter ma - gnam

32 Bc 

39f. Ob II, VI II 

39 Va 

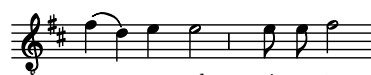
39 T  ma - gnam glo - ri - am tu -

5 Fl I, II 2 **B 11, B 12:** ♯ instead of ♮ (cf. S I); SBA emends in accordance with Ob I, VI I

8 Ob II 10 **A:** c^{#1} instead of e¹ (below the instrument's compass)

9 Fl I 4 **B 11:** erroneously ♮ instead of ♯

21 Ob II 10 **A:** c^{#1} instead of f^{#1} (below the instrument's compass)

23 Ob II **A:** colla parte with A (below the instrument's compass)

30 Fl II 1-2 **B 12:** ♮ instead of ♯; but cf. Fl I and Ob I

40 Va 5-8 **A:** ♯ f^{#1}-d¹; cf. T

43 S I **A:** with text underlay "bi" instead of "am"

7a. Domine Deus

For the reuse of this movement in BWV 191 (1742) see above, 4a. *Gloria in excelsis Deo*.

1 Fl I 5-6 **B 11:** with slur, but cf. mm. 3, 5 etc.

2 VI I, VI II, Va **A:** "sourdini" at Va part only

28 T 3 **B 4:** erroneously ♮ instead of ♯

38 VI I 1-2 **B 16:** with slur

42 VI I 2-9 **A:** slur on 2-7

42 VI II 2-9 **A:** slur on 2-5; **B 18:** slur on 2-5, but extended until note 9

42 Va 2-9 **B 19:** slur on 2-5 and 6-9

59 Bc 5 **B 21:** fig. $\frac{6}{4}$ instead of $\frac{6}{3}$

78 Fl I 5-6 **A:** with slur, apparently in a foreign hand

80 S I 3 **B 1:** ♮ instead of ♯

80 T 4 **A:** b instead of e¹

93 T 1-2 **A:** lacks text underlay

93 T 2 **A:** superfluous ♯ after note 2

95 T **A:** lacks text

7b. Qui tollis

This movement originates from movement 1 "Schauet doch und sehet, ob irgend ein Schmerz sei" of the cantata with the same title BWV 46 (1723; in D minor).

Later revisions in A

99f. VI I 

99 A  mun - di,

101f. Va 

125 VI I 

125 VI II 

128 Va 

130 S I  - sci-pe de - pre - ca - ti -

132 Fl II 

132 VII 

132 S I  de - pre - ca - ti -

95 Vc, Bc 4 **A:** notation suggests that Vc has ♯ and Bc has ♮ B; **B 20, B 21:** ♯ instead of ♮; SBA emends to pattern of mm. 96ff.

96 - **"Lente" in B 3, B 20, and B 21 only; B 16:** "Adagio"

96 Bc **B 21:** lacks "col arco e staccato"

116 A **A:** superfluous text underlay "re" (after line break)

117 B 1-2 **A:** with slur (but cf. text underlay)

119 Bc 2 **B 21:** fig. $\frac{6}{2}$ instead of $\frac{6}{3}$

133 VI II 1 **B 18:** with ♯; but cf. Fl I and A

8. Qui sedes

Later revisions in A

50 A  no - bis,

53-56 A  - des ad dex - tram Pa - tris, mi - se - re - re no - bis,

68 A  no - bis,

1 (upbeat) A **B 3:** "Solo"

9 Obda 7-12 **A:** slurs on 8-9, 10-11, 12f. instead of 7-8, 9-10, 11-12

10 VI II 3 **A:** with staccato dot

12 Obda 9-12 **A:** slurs on 9-10, 11-12 instead of 9-12

17 Obda **A:** slurs on 1-6 and 7-12 instead of 1-2, 3-6, 7-8, 9-12

19 Obda **A:** pp (other parts without dynamics)

44 Va **B 19:** bar is missing

50 VI I 5-8 **A, B 16:** slurs on 5-6, 7-8; but cf. Obda, VI II

53 Bc 4-5 **A:** with staccato dots

71 Va 6 **B 19:** with staccato dot

74 Obda, Bc **B 13, B 20, B 21:** "Adagio" already at 73/5

79 Bc 4 **B 21:** fig. $\frac{6}{3}$ instead of $\frac{6}{2}$

85 Obda 9-12 **A:** slurs on 9-10, 11-12 instead of 9-12

86 VI I 2 **B 16:** ♮ instead of ♯

9a. Quoniam tu solus sanctus

Later revisions in A: see *ossia* staff in SBA

2 Fg I **A:** slurs on 4-5, 6-7 instead of 4-7

13 Fg I, II 3 **B 15:** p already at note 1 (between the two staves)

34 Fg I **A:** slurs on 4-5, 6-7 instead of 4-7

35 Bc 1 **B 21:** fig. $\frac{6}{2}$ instead of $\frac{7}{2}$

37-38 B **A:** slur starts at the beginning of m. 38 after line break

52 Fg II 4 **A:** d¹ instead of f^{#1}

55f. Fg II 1-5 **A:** 

64	Fg II	A: slur on 1–3 instead of 4–7
67	B 1	A: rather ♭ than ♮
78	Bc 3	B 21: fig. 7 instead of ♯
84	Fg I 1–3	B 15: with slur
84, 86	Fg I, II 4–7	A: slurs on 4–5, 6–7 instead of 4–7
99	B 2	A: a instead of A
100	Bc 4	B 21: fig. 5+ instead of 5±
107	Bc 6	B 20: erroneously G instead of A
112	Bc 4	B 21: fig. $\frac{6}{2}$ instead of 6
125	Bc 1	B 21: fig. $\frac{6}{5}$ instead of $\frac{7}{5}$

9b. Cum Sancto Spiritu

For the reuse of this movement in BWV 191 (1742) see above, 4a. *Gloria in excelsis Deo*.

Later revisions in A
217–218 Bc



236–238 T



128	Cor 1	A, B 10: ♮ with fermata (in A for lack of space); SBA adapts to the notation of Fg I, II in B 15
128	Fg I, II 1	A: ♮ with fermata
128	S I, II	B 1, B 2: lack "Vivace"
132	Bc 2–3	A: with slur
139	VI II 2–3	B 18: with slur
148	Fl II 4–7	B 12: with slur on 4–7 instead of 4–5, 6–7; SBA adapts to Fl I
148	Ob I 8–11	B 14: slurred in pairs; SBA adapts to Ob I
149	Fl I	B 11: slurs on 1–2, 3–4, 5–8, 9–12; SBA adapts to Fl II
150	Fl I 5–8	B 11: with slur on 5–8 instead of 5–6, 7–8; SBA adapts to Fl II
150	Fl II 1–4	B 12: slurred in pairs; SBA adapts to Fl I
150, 151	Ob II 5–8	B 14: slurred in pairs; SBA adapts to Ob I
150	Bc 4	B 21: with unclear fig. (6?), but cf. Va, T
151	Fl I 5–12	B 11: slurs on 5–8, 9–12; SBA adapts to Fl II
163	Fl II 9–12	B 12: slurs on 9–10, 11–12 instead of 9–12
163	Va 8	A: e ⁷ instead of d ⁷ ; but cf. T
174	A 2–4	B 3: with slur (to clarify beaming after correction)
178	Bc 2	B 21: fig. 6 not until 7
184f.	A	A: incomplete text underlay, "-tris, a-" missing
186	T 2	A: f [♯] instead of f [♮]
188	S II 3	B 3: without ♯; A: ♯ added later by JSB
200	Fl I 4	B 11: lacks ♯
200	Bc 5	B 21: lacks ♯
201	Tr II 2	A: with ♯
205	Tr II 2	A: with ♯
205	Bc	A: octave higher
206	S II, A	A: lack text (added by CPEB)
214	Bc 5	B 21: fig. 5 not until last note
219, 224	Bc 4	B 21: fig. 7 8 instead of 8 7
226	Fl I, Ob I, VII 7	A: g ² instead of a ² ; cf. S II and parallel instances
226	S I	A: with slur on 9–11; B 1: with slur on 10–11



232	A 1	A: d ⁷ instead of 7
234	A 5–8	A: with slur
240	VI I 4–5	B 16: with slur

249–253 B



253	S II 1–2	A: without text underlay
254	Bc 2	B 21: fig. $\frac{7}{5}$ instead of $\frac{6}{4}$

10. Credo in unum Deum

This movement is based on a Credo intonation BWV deest (in G major), a copy of which has been preserved at the Forschungsbibliothek Gotha, shelfmark *Mus. 2° 54c/3*.

6, 9	Bc 6	A: fig. - added in a foreign hand, possibly by J. H. Michel
10	Bc 7	A: fig. $\frac{5}{4}$ instead of $\frac{6}{4}$

11. Patrem omnipotentem

This movement originates from the opening chorus of the cantata *Gott, wie dein Name, so ist auch dein Ruhm* BWV 171 (c. 1729; in D major)

6	T	A: text underlay added by CPEB
7–8	A	A: text underlay added by CPEB (late)
24–25	A	A: text underlay "coe-li" added by CPEB; JSB's reading can no longer be deciphered
25	T 8	A: text underlay "et" added by CPEB (possibly changed from "in")
29–30	S	A: text underlay "et ter-r" added by CPEB (possibly for clarification only)
37	S 2	A: d ² in CPEB's hand, possibly corrected from c ^{♯2}
42	T	A: text underlay added by CPEB
42	Bc 1	A: ♭ (without ♯) instead of ♮
56	VI I 3	A: ♯ added by CPEB; cf. Ob I
56	S 3	A: ♯ added in a foreign hand; cf. Ob I
56	A 2–4	A: with melismatic slur
64–71	B	A: changed by CPEB (late) to



74	VI I 3	A: notehead notated somewhat low, can be misread as d ²
77	Ob I, VI I 2–4	A: step lower, but cf. S; SBA follows D
83	VI II 2	A: tr added by CPEB
83	S 1–3	A: with melismatic slur in CPEB's hand
84	-	A: measure count "84" added in a foreign hand

12. Et in unum Dominum

A short fragment of this movement (four measures, VI I only; in C major) is found in the autograph score of the dramma per musica *Lasst uns sorgen, lasst uns wachen* BWV 213 (1733).⁶ The movement apparently stems from an older (secular) cantata which is now lost.

The movement underwent substantial revision in A. It originally also contained the text "Et incarnatus est de Spiritu Sancto ex Maria virgine et homo factus est." Bach added 13. *Et incarnatus est* as an afterthought and rewrote the vocal parts on pp. 151–152 of the autograph score A (see *I. The Sources*). For the edition the earlier version of the vocal parts on pp. 106–110 of A is regarded as irrelevant; earlier version on DVD.

5	VI II 4–5	A: staccato dots apparently erased by a foreign hand
17	VI I 2	A: unclear whether d ² or e ²
21	VI II 5–6	A: entered by CPEB in analogy with VI I, replacing original -
32	Ob II, VI II	A: a ⁷ changed to b ⁷ , apparently by CPEB (late)
66	Ob I, VI I 9–11	A: without staccato dots for lack of space
67–68	A	A: text underlay added a second time by J. H. Michel for clarification
70	A 5	A: reading of the final version can no longer be deciphered; SBA follows ante correcturam reading from the original version of this movement.
72	A	A: text underlay incomplete, "nos" apparently added by CPEB

13. Et incarnatus est

On the late insertion of this movement see above, 12. *Et in unum Dominum*.

2	VI I, II 2	A: notehead notated somewhat low, can be misread as a ⁷
8	Bc	A: fig. $\frac{8}{3}$ added by CPEB
11	B 2	A: e [♯] (parallel octaves with A); emended to g [♯] in correspondence with Bc
13	A 1	A: ♭ ♯; in SBA adapted to T, B
16	Bc	A: slur rather on notes 2–3 only
28	A 2	A: notehead entered by CPEB; JSB's reading can no longer be deciphered
36–37	A	A: distribution of text changed by CPEB (late); SBA follows C, D
36–37	Bc	A: tie for 36/3–37/1 added by CPEB (late; in misunderstood analogy with B)

⁶ Staatsbibliothek zu Berlin – Preussischer Kulturbesitz, shelfmark *Mus. ms. Bach P 125*.

14. Crucifixus

This movement originates from movement 2 "Weinen, Klagen Sorgen, Zagen" of the cantata with the same title BWV 12 (1714; in F minor).

- 7 A A: text underlay added by CPEB
 17 Bc 3 A: upper figure "6" added by CPEB

15. Et resurrexit

- 2 Tr I 5 A: with staccato dot
 15 T 2 A: changed from g^1 to $f^{\sharp 1}$, apparently by CPEB (late); SBA follows C, D
 19 S II 6 A: apparently changed from $c^{\sharp 2}$ to d^2 by CPEB late; SBA follows C, D
 31 S II 2 A: text underlay "xit" added by CPEB
 53 S II 1-2 A: rhythmically and textually adapted by CPEB to match A
 58 T 6 A: illegible after several corrections; SBA follows C ante correcturam (preceding γ missing); changed by CPEB to $c^{\sharp 2}$ in C and A
 63 S I 4-5 A: \downarrow ; adapted to S II, A
 65 S I 1-3 A: \downarrow ; d^2 - $c^{\sharp 2}$ - d^2 - e^2 (CPEB late)
 73-80/1 Timp A: (empty) system originally omitted on p. 125; entered between Va and S I
 76 B 6-9 A: reading unclear; SBA follows C, D
 79-80 B A: slur ends at 80/4 due to line break
 84 Bc 4-7 A: slur starts at note 2; emended in analogy with m. 81 and 82-83 resp.
 98 A A: heavily corrected, probably by JSB himself; measure entered in the lower margin by CPEB for clarification
 109 T 2 A: changed from $c^{\sharp 2}$ to e^2 by CPEB (late)
 110 A 6 A: notehead notated somewhat high, can be misread as e^1
 110 Bc 4 A: replaced by \downarrow ; $f^{\sharp 2}$ - e by CPEB
 125 Tr II A: $\#$ in CPEB's hand (possibly only for clarification)

16. Et in Spiritum Sanctum

- 11 Obda I, II 1-3 A: staccato dots overwritten with slur by CPEB (late)
 19 Bc 1 A: notehead notated somewhat high, can be misread as g
 84 B 5-6 A: changed from $f^{\sharp 2}$ - $g^{\sharp 2}$ to $e^{\sharp 2}$ - $f^{\sharp 2}$ by CPEB (late); SBA suggests \sharp to last note of Bc for harmonic reasons instead
 116 B 5-7 A: replaced by \downarrow ; d^1 by CPEB
 126, 128 Obda I, II A: \downarrow -appoggiaturas changed by CPEB to \downarrow
 134 Bc 1 A: notehead notated somewhat high, can be misread as b
 144 Obda I 1-2 A: \downarrow ; SBA emends in analogy with Obda II

17a. Confiteor

- Coro A: note 3 of the main theme was changed by Bach in all vocal parts (S I, m. 2; S II, m. 3; A, m. 5; T, m. 6; B, m. 8) from a second step to a tone repetition. From m. 32 on the final version was directly entered into the score.
 24 S II A: heavily corrected

 47 S II 2 A: changed from $c^{\sharp 2}$ to b^1 by CPEB (returning to an ante-correcturam reading of JSB)
 107 A 2 A: unclear whether $g^{\sharp 1}$ or g^1 (a neighboring note $g^{\sharp 1}$ would have been reasonable despite $g^{\sharp 1}$ in S I, Bc); \sharp to note 3 apparently added by CPEB
 121 - A: "Adagio" added in a foreign hand, possibly by JCFB (during the lifetime of his father)

17b. Et expecto

This movement originated from movement 2 "Jauchzet, ihr erfreuten Stimmen" of the cantata *Gott, man lobet dich in der Stille* BWV 120 (1728 or 1729).

- 142 all A: new key signature at the beginning of p. 140 (after page turn); SBA emends to match beginning of new section at m. 147
 147 - A: "Vivace è Allegro" (possibly already at last beat of m. 146) added in a foreign hand, possibly JCFB (during the lifetime of his father)
 193 B 2 A: apparently changed from b to a by CPEB (late); SBA follows C, D
 218 A A: changed by CPEB to

to avoid parallel octaves between A and Bc

18a. Sanctus

This movement originated – together with 18b. *Pleni sunt coeli* – as *Sanctus in D* BWV 232^{III} (1724).⁷

- 7 Tr II 2 A: notehead notated somewhat high, can be misread as e^2
 11 Tr II 2 A: notehead notated somewhat low, can be misread as d^2

- 15 Tr I 2 A: without \downarrow , but cf. T
 24 A I 6-8 A: erroneously with text underlay "Is-ra-el" instead of "Sa-ba-oth"
 38 VI I 5 A: notehead notated somewhat high, can be misread as $f^{\sharp 2}$
 41-43 VII A: erroneously part of Ob III entered and immediately wiped out, but not fully deleted
 46 VII 7 A: notehead notated somewhat high, can be misread as g^2

18b. Pleni sunt coeli

On the origin of this movement see 18a. *Sanctus*.

- 56 Bc 3 A: corrected from e to a (possibly by CPEB), but this corr. leads to parallel fifths between Bc and T
 60 T A: text underlay "tua"; changed to "ejus" by CPEB
 66 T 1 A: notehead notated somewhat low, could be misread as c^{\sharp}
 77 T 2 A: erroneously \downarrow instead of \downarrow
 84 A II A: with erroneous text underlay "ple-"; SBA follows C, D
 84-88 A II A: notated in tenor clef up to 88/2
 92 A I A:  (but cf. m. 91)
 92-93 S I A: with erroneous text underlay "tua" instead of "ejus"
 115 Ob III 2-6 A: with slur
 119 A I 1 A: b instead of $f^{\sharp 1}$ (erroneously not transposed from soprano to alto clef when copying from the autograph score of BWV 232^{III} (Staatsbibliothek zu Berlin – Preussischer Kulturbesitz, shelfmark *Mus. ms. Bach P 13*)
 141 VI II 1 A: notehead notated somewhat low, can be misread as d^1
 147 Ob III 2 A: notehead notated somewhat high, can be misread as $f^{\sharp 1}$

19. Osanna in excelsis

This movement originated as the opening chorus of the cantata *Preise dein Glück, gesegnetes Sachsen* BWV 215 (1734), respectively as the model.

- 29 Va 2 A: notehead notated somewhat low, can be misread as $f^{\sharp 1}$, but cf. T
 77 Fl I A: entered by CPEB; JSB's reading can no longer be deciphered
 96 Ob II, VI II 2 A: lack \sharp , but cf. m. 140
 102 Tr I 2 A: d^2 instead of e^2 ; SBA adapts to Fl I, Ob I, VI I rather than to S II

20. Benedictus

- 12 T 3-5 A: with slur, possibly by CPEB
 19 Bc 1-6 A: slurs on 1-2, 3-6 respectively due to line break after note 2
 21 Bc 5 A: notehead notated somewhat high, can be misread as a
 23 Bc 1-6 A: slur on 1-2 only, not continued after page turn
 35 Fl 3-8 A: slur on 6-8 only

21. Osanna repetatur

no remarks

22. Agnus Dei

This movement originates from movement 5 "Seele, deine Spezereien" of the *Himmelfahrtssoratorium* (Oratorio for Ascension Day) BWV 11 (1725; in B minor), respectively from the model. As in 2. *Christe eleison*, the violins are notated on one staff line in soprano clef ("Violini I unisoni").
no remarks

23. Dona nobis pacem

On the origin of this movement see above, 6. *Gratias agimus tibi*.

- 14-15 B A: with erroneous text underlay "do-cem" (page turn); SBA emends to "do-na"
 46 - A: all parts have \equiv (i.e., \equiv ?); SBA adapts to 6. *Gratias agimus tibi*, m. 46

⁷ Cf. *Johann Sebastian Bach, Sanctus in D BWV 232^{III}*, ed. Ulrich Leisinger, Stuttgart, 2000 (Carus 31.232/50).

Konkordanz / Concordance

	NBA II/1 1954 Smend [BA 5102]	Wolff 1997 [EP 8735] Rifkin 2006 [B&H 5363]	NBA ^{rev 1} 2010 Wolf Carus 2014 Leisinger	Takte/ measures
I. Missa				
Kyrie I	1	1	1	
Christe eleison	2	2	2	
Kyrie II	3	3	3	
Gloria in excelsis Deo	4	4	4a	(T. 1–100)
Et in terra pax	5	5	4b	(T. 101–176)
Laudamus te	6	6	5	
Gratias agimus tibi	7	7	6	
Domine Deus	8	8	7a	(T. 1–95)
Qui tollis	9	9	7b	(T. 95–145)
Qui sedes	10	10	8	
Quoniam tu solus sanctus	11	11	9a	(T. 1–127)
Cum Sancto Spiritu	12	12	9b	(T. 128–255)
II. Symbolum Nicenum				
Credo in unum Deum	1	13	10	
Patrem omnipotentem	2	14	11	
Et in unum Dominum (1. Version)	3	(EP: Anh. II)	–*	
Et in unum Dominum (2. Version)	(Variante)	15	12	
Et incarnatus est	4	16	13	
Crucifixus	5	17	14	
Et resurrexit	6	18	15	
Et in Spiritum Sanctum	7	19	16	
Confiteor	8	20	17a	(T. 1–123)
Et expecto (1)	–	–	17b	(T. 123–251)
Et expecto (2)	9	21	–	(T. 147ff.)
III. Sanctus				
Sanctus	o.N.	22	18a	
Pleni sunt coeli	o.N.	o.N.	18b	
IV. Osanna, Benedictus, Agnus Dei et Dona nobis pacem				
Osanna in excelsis	1	23	19	
Benedictus	2	24	20	
Osanna repetatur	3	25	21	
Agnus Dei	4	26	22	
Dona nobis pacem	5	27	23	

* als PDF-Datei auf der DVD zu CV 31.232/01 / as PDF file on the DVD accompanying CV 31.232/01